

Instruction Manual

PORTABLE
CONDUCTIVITY METER
ES-71

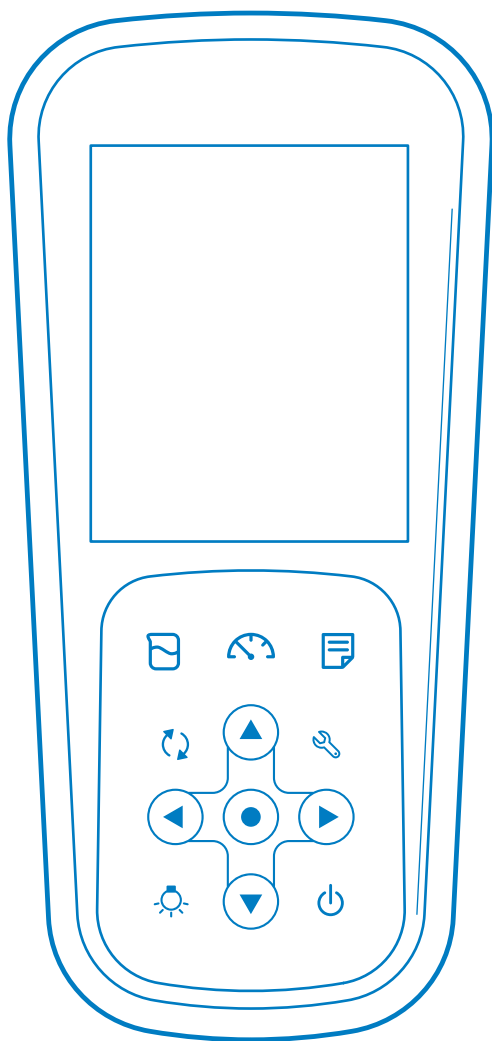

Preface

Part names and
basic operation

Measurement

Using various
functions

Maintenance

How to resolve errors
or troubles

Appendix

Preface

This manual describes the operation of the Portable Conductivity Meter ES-71.

Be sure to read this manual before using the product to ensure proper and safe operation of the product. Also safely store the manual so it is readily available whenever necessary.

Product specifications and appearance, as well as the contents of this manual are subject to change without notice.

■ Warranty and responsibility

HORIBA, Ltd. warrants that the Product shall be free from defects in material and workmanship and agrees to repair or replace free of charge, at option of HORIBA, Ltd., any malfunctioned or damaged Product attributable to responsibility of HORIBA, Ltd. for a period of one (1) year from the delivery unless otherwise agreed with a written agreement. In any one of the following cases, none of the warranties set forth herein shall be extended;

- Any malfunction or damage attributable to improper operation
- Any malfunction attributable to repair or modification by any person not authorized by HORIBA, Ltd.
- Any malfunction or damage attributable to the use in an environment not specified in this manual
- Any malfunction or damage attributable to violation of the instructions in this manual or operations in the manner not specified in this manual
- Any malfunction or damage attributable to any cause or causes beyond the reasonable control of HORIBA, Ltd. such as natural disasters
- Any deterioration in appearance attributable to corrosion, rust, and so on
- Replacement of consumables

HORIBA, LTD. SHALL NOT BE LIABLE FOR ANY DAMAGES RESULTING FROM ANY MALFUNCTIONS OF THE PRODUCT, ANY ERASURE OF DATA, OR ANY OTHER USES OF THE PRODUCT.

■ Trademarks

- Microsoft, Windows, Windows Vista are registered trademarks or trademarks of Microsoft Corporation in the United States and other countries.

Other company names and brand names are either registered trademarks or trademarks of the respective companies. (R), (TM) symbols may be omitted in this manual.

Check items

■ Items in package

After opening the package, check for damage on the instrument and that the standard accessories (see below) all exist.

If damage or defects are found on the product, contact your dealer.

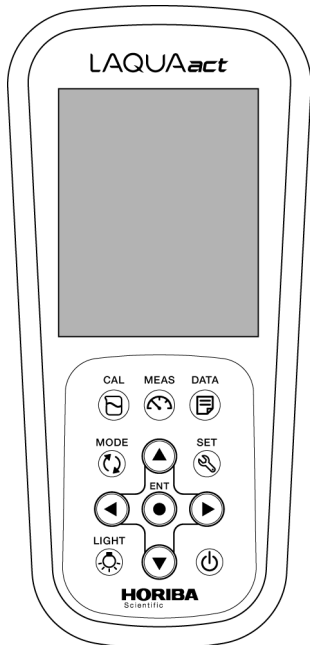

Instrument

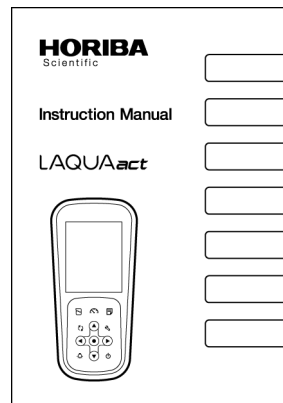

Instruction manual
(this book)

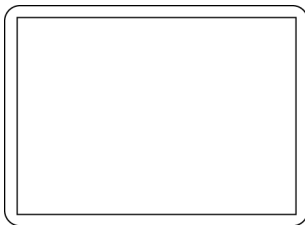

Quick-start Manual



AAA alkaline batteries

Note

- The accessories are not waterproof.
 - The supplied alkaline batteries are used to check operation, thus it is possible that the battery will be run out quickly.
-

Regulations

■ Conformable Directive

This equipment conforms to the following directives and standards:



Directives: The EMC Directive 2004/108/EC
The Low Voltage Directive 2006/95/EC
The RoHS Directive 2011/65/EU

Standards: [the EMC Directive] EN61326-1:2006
Class B, Basic requirements
[the Low Voltage Directive] EN61010-1:2010(Ed.3.0)
[the RoHS Directive] EN50581:2012
Category: 9. Monitoring and control instruments

● Installation Environment

This product is designed for the following environment.

- Overvoltage Category II
- Pollution degree 2

WARNING: Do not use the equipment for measurements within measurement categories II, III and IV.

● Information on disposal of electrical and electronic equipment and disposal of batteries and accumulators

The crossed out wheeled bin symbol with underbar shown on the product or accompanying documents indicates the product requires appropriate treatment, collection and recycle for waste electrical and electronic equipment (WEEE) under the Directive 2002/96/EC, and/or waste batteries and accumulators under the Directive 2006/66/EC in the European Union.

The symbol might be put with one of the chemical symbols below. In this case, it satisfies the requirements of the Directive 2006/66/EC for the object chemical.

This product should not be disposed of as unsorted household waste.

Your correct disposal of WEEE, waste batteries and accumulators will contribute to reducing wasteful consumption of natural resources, and protecting human health and the environment from potential negative effects caused by hazardous substance in products.

Contact your supplier for information on applicable disposal methods.

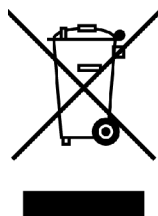

Regulations

■ FCC rules

Any changes or modifications not expressly approved by the party responsible for compliance shall void the user's authority to operate the equipment.

●WARNING

This equipment has been tested and found to comply with the limits for a Class A digital device, pursuant to part 15 of the FCC Rules. These limits are designed to provide reasonable protection against harmful interference when the equipment is operated in a commercial environment. This equipment generates, uses, and can radiate radio frequency energy and, if not installed and used in accordance with the instruction manual, may cause harmful interference to radio communications.

Operation of this equipment in a residential area is likely to cause harmful interference in which case the user will be required to correct the interference at his own expense.

■ Korea certification

●B급 기기 (가정용 방송통신기자재)

이 기기는 가정용(B 급) 전자파적합기기로서 주로 가정에서 사용하는 것을 목적으로 하며, 모든 지역에서 사용할 수 있습니다.

■ Taiwan battery recycling mark



廢電池請回收

For your safety

■ Hazard classification and warning symbols

Warning messages are described in the following manner. Read the messages and follow the instructions carefully.

● Hazard classification



This indicates an imminently hazardous situation which, if not avoided, will result in death or serious injury. This is to be limited to the most extreme situations.



This indicates a potentially hazardous situation which, if not avoided, could result in death or serious injury.



This indicates a potentially hazardous situation which, if not avoided, may result in minor or moderate injury. It may also be used to alert against unsafe practices.
Without safety alert indication of hazardous situation which, if not avoided, could result in property damage.

● Warning symbols



Description of what should be done, or what should be followed





Description of what should never be done, or what is prohibited



For your safety

■ Safety precautions

This section provides precautions for using the product safely and correctly and to prevent injury and damage. The terms of DANGER, WARNING, and CAUTION indicate the degree of imminency and hazardous situation. Read the precautions carefully as it contains important safety messages.





● Instrument and electrode



 WARNING	
	Do not use an unspecified AC adapter. Otherwise, it may heat up or be ignited resulting in a fire or an accident.
	Do not disassemble or modify the instrument. Otherwise, it may heat up or be ignited resulting in a fire or an accident.

 CAUTION	
	Do not use the RS-232C communication and the AC adapter under wet or humid conditions. Otherwise, it may cause a fire, electric shock, or breakage.

For your safety

● Battery

 WARNING	
	Keep batteries out of reach of children. If someone accidentally swallows a battery, consult a doctor immediately.
	If alkaline fluid from a battery gets into the eyes, do not rub the eyes, rinse with clean water immediately and then consult a doctor. Contact with alkaline fluid could cause blindness.
	Do not put batteries in a fire, expose to heat, disassemble or remodel. Doing so could cause fluid leakage, overheating or explosion.

 CAUTION	
	Do not remove or scratch the external label of the battery. Doing so could cause injury to hands and fingers.

■ Product handling information

● Operational precautions (instrument)

- Do not drop, crash, or give any physical impact on the instrument.
- The instrument is made of solvent-resistant materials but that does not mean it is resistant to all chemicals. Do not dip the instrument in strong acid or alkali solution, or wipe with such solution.
- If the instrument is dropped into water or gets wet, wipe it using soft cloth. Do not heat to dry it with a hair-dryer (or the like).
- The instrument has a dust-proof and waterproof structure. Waterproof performance is following specification: the instrument does not malfunction even when immersed in water of 1 m depth for 30 minutes.
This does not mean to guarantee non-destructive, trouble-free, dust-proof, and waterproof performance in all situations. If the instrument is correctly handled according to the descriptions in this manual, the instrument provides dust-proof and waterproof performance.
- When replacing the batteries, while connected to the AC adapter, or during the RS-232C communication, the instrument does not have the dust-proof and waterproof performance. The dust-proof and waterproof performance is maintained only when the covers are attached correctly.
- After replacing the batteries, connecting the AC adapter, and using the RS-232C communication, make sure that the waterproof packing attached to each cover is not deformed or discolored, or has foreign matter adhering to it. If the waterproof packing is deformed, discolored or has foreign matter adhering to it, or dust could get inside, water leaks could occur that could lead to instrument malfunction.
- To disconnect an electrode or AC adapter cable or serial cable, hold the connector and pull it off. If you pull at the cable, it may cause a breakage.
- The RS-232C communication between the instrument and a personal computer (PC) may fail because of environmental conditions, such as (radio/electromagnetic) noise.
- Do not replace the batteries, connect the AC adapter, or use the RS-232C communication in a dusty place or with wet hands. Dust or moisture could get inside the instrument, possibly causing instrument malfunction.
- Do not use the tip of a nail or an object with a sharp end to press the keys.
- If the power supply is interrupted while measurement data is being saved in the instrument, the data could be corrupted.
- A Ni-MH rechargeable battery can be used in this instrument, but the battery used in the instrument cannot be charged using the AC adapter.

For your safety

● Operational precautions (battery)

- Do not short circuit a battery.
- Set the + and – side of the battery correctly.
- When the battery has run out or the instrument will not be used for a long time, remove the batteries.
- Of the specified battery types, make sure to use two batteries of the same type.
- Do not use a new battery together with a used battery.
- Do not use a fully charged nickel-metal hydride battery together with a partially charged battery.
- Do not attempt to charge a non-rechargeable battery.

● Environmental conditions for use and storage

- Temperature: 0°C to 45°C
- Humidity: under 80% in relative humidity and free from condensation

Avoid the following conditions.

- Strong vibration
- Direct sunlight
- Corrosive gas environment
- Close to an air-conditioner
- Direct wind

● Transportation

When transporting the instrument, repackage it in the original package box. Otherwise, it may cause instrument breakage.

● Disposal

- Standard solution used for the calibration must be under neutralized before the disposal.
- When disposing of the product, follow the related laws and/or regulations of your country for disposal of the product.

■ Manual Information

● Description in this manual

— **Note** —

This interprets the necessary points for correct operation and notifies the important points for handling the product.

— **Reference** —

This indicates the part where to refer for information.

— **Tip** —

This indicates reference information.

Contents

Preface	I
■ Items in package.....	II
■ Hazard classification and warning symbols	V
■ Safety precautions	VI
■ Product handling information	VIII
■ Manual Information	X
Part names and basic operation.....	1
■ Names of each part	2
● Instrument.....	2
● Display	3
● Operation key	5
■ Basic operation.....	6
● Changing the operation mode	6
● Changing the measurement parameter	7
● Using the backlight.....	8
● Entering numeric values	9
Measurement	11
■ Preparation.....	12
● Confirmation before starting measurement	12
● Turning ON the instrument	13
● Setting the date and time	15
● Connecting an electrode	16
■ Conductivity measurement	17
● Setting the instrument.....	18
● Performing salinity calibration	23
● Performing measurement	25
Using various functions	27

Contents

● Saving measurement data in the internal memory.....	28
● Displaying saved data.....	29
● Deleting all saved data.....	30
● Deleting calibration data.....	31
● Printing measured values and calibration data.....	33
● Transferring saved data to a PC.....	35
● Operating the instrument from an external device.....	36
● Using the automatic data save (default: OFF).....	37
● Setting the ID number (default: 000).....	39
● Calibrating temperature sensor.....	40
● Changing the automatic power off setting (default: OFF)....	41
● Performing test printing of the printer unit.....	42
● Resetting to factory default settings.....	43
Maintenance.....	45
● Maintenance and storage of the instrument.....	45
● Environmental conditions for storage.....	45
● Maintenance and storage of the conductivity cell.....	46
● Checking and calibrating the conductivity cell.....	47
How to resolve errors or troubles.....	49
■ When an error message appears.....	49
● ERR No.0001 Memory error.....	49
● ERR No.0002 Empty battery level.....	49
● ERR No.0003 Electrode stability error.....	50
● ERR No.0009 Printer error.....	50
● ERR No.0010 Memory full.....	50
● ERR No.0011 Cell constant is out of range.....	50
■ Troubleshooting.....	51
● The indicated value fluctuates.....	51
● The response is slow.....	51

Contents

● The indicated value does not change/No response	52
● The measured value blinks	52
● Repeatability of the measured value is poor.....	52
● The temperature display blinks or is fixed at 25°C	53
● Nothing appears when the power is turned ON	53
● Swelling of operation key sheet	53
● Part of the display is missing	54
Appendix.....	55
■ Main specifications	55
● Table of conductivity cell range	57
● Table of conductivity cell range (resistivity range)	58
■ Instrument default settings	59
■ Technical note	60
● Conductivity measurement.....	60
■ For more information	62
■ Options	63



Part names and basic operation

This section describes the name of each part and the main role, function, and basic operation method of each part.

■ Names of each part.....	2
● Instrument.....	2
● Display.....	3
• Battery level display	4
● Operation key	5
■ Basic operation	6
● Changing the operation mode	6
● Changing the measurement parameter.....	7
● Using the backlight	8
● Entering numeric values.....	9

■ Names of each part

● Instrument

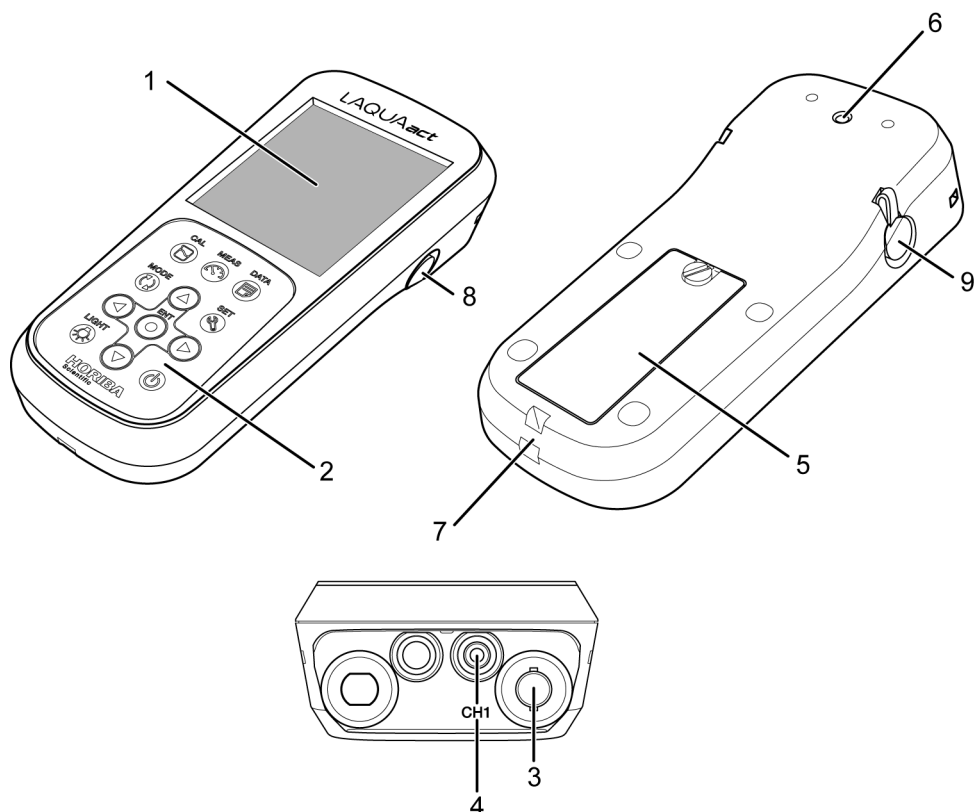

No.	Name	Function
1	Display	Displays the measured value and set value and so on.
2	Operation keys	Used for instrument operation.
3	Electrode connector	Connects the BNC connector of the electrode.
4	Temperature connector	Connects the temperature connector of the electrode.
5	Battery cover	Set batteries inside.
6	Electrode hook attachment section	Attach the electrode hook to carry with instrument.
7	Strap attachment section	Attach a strap.
8	Serial connector	Connects the serial cable and printer cable.
9	AC power connector	Connects an optional AC adapter.

● Display

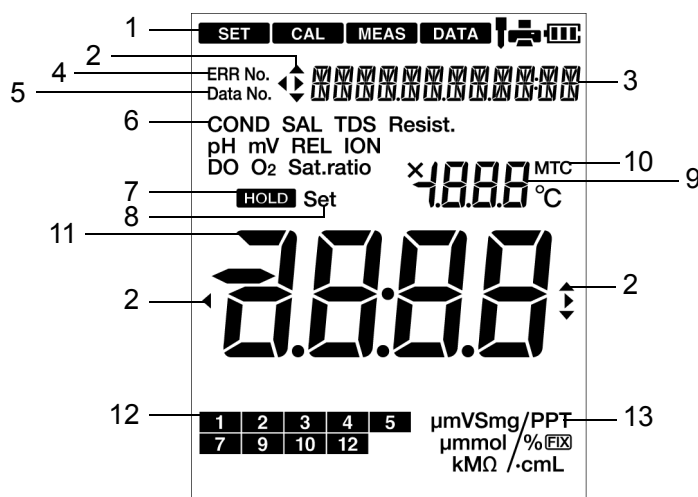

No.	Name	Function
1	Status icon	Displays the current operation mode, electrode status, printer or PC connection status, and remaining battery level.
2	Direction key icon	Displays the currently available direction key.
3	Date and time, set item display area	Displays the current date and time and the set items.
4	ERR No. icon	Displays an error No.
5	Data No. icon	Displays the data No.
6	Measurement parameter display area	Displays the currently set measurement parameter.
7	HOLD icon	Lights when the measured value display is fixed.
8	SET icon	Lights when numerical values are entered.
9	Temperature display area	Displays the measured and the set temperature.
10	MTC icon	Lights when the temperature setting is MTC (optional temperature setting).
11	Measured value, set item display area	Displays the measured value and the set value.
12	Standard solution calibration history icon	When calibrating pH standard solution, the corresponding icon lights. (this icon do not use in the instrument).
13	Unit display area	Displays the unit for the measurement parameter and the display item.

• **Battery level display**



Battery level is high.



Battery level is a little lower.



Battery level is low.
The backlight may become unavailable.



Battery has run out. Replace the batteries.
"ERR No. 0002" is displayed and operation is disabled.

● Operation key

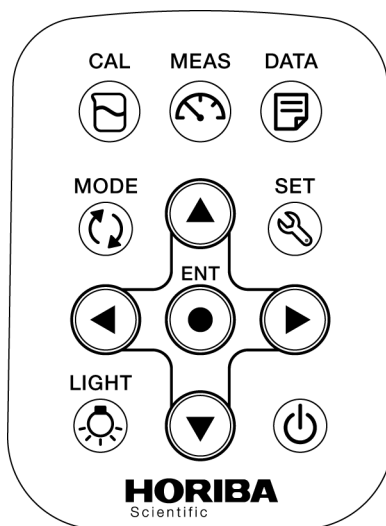

Key	Name	Function
	MEAS key	Changes the operation mode to the measurement mode during operation in a different mode. The changes you made using the setting mode are reflected when you press this key to return to the measurement mode. In the measurement mode, switches the automatic hold measurement on/off.
	CAL key	Changes from the measurement mode to the calibration mode. Start calibration in the calibration mode.
	DATA key	Changes from the measurement mode to the data mode.
	SET key	Changes from the measurement mode to the setting mode.
	POWER key	Turns ON/OFF the power of instrument.
	MODE key	In the measurement mode, changes measurement parameters.
	LIGHT key	Turns on/off the backlight.
	ENTER key	Determines the selection or setting. Prints data in measurement, the calibration and data mode.
	UP key	Changes the selected item.
	DOWN key	Changes the number of the selected digit when entering numbers.
	LEFT key	Changes the selected item.
	RIGHT key	Changes the selected digit when entering numbers.

■ Basic operation

● Changing the operation mode

This instrument is operated by changing the operation mode from four available modes, depending on the purpose of use. The status icon indicates the current mode. You can change the operation mode using the corresponding key. However changing to the calibration, data, or setting mode is available only from the measurement mode.

When changing to a different mode, first change to the measurement mode and then change to the desired mode.

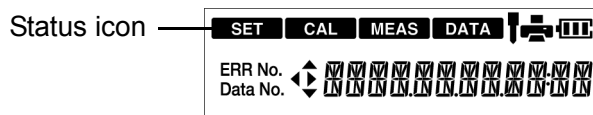

Icon	Name	Function
MEAS	Measurement mode	Performs measurement.
CAL	Calibration mode	Performs calibration.
DATA	Data mode	Saves data in the internal memory. Displays the saved data.
SET	Setting mode	Performs various settings.

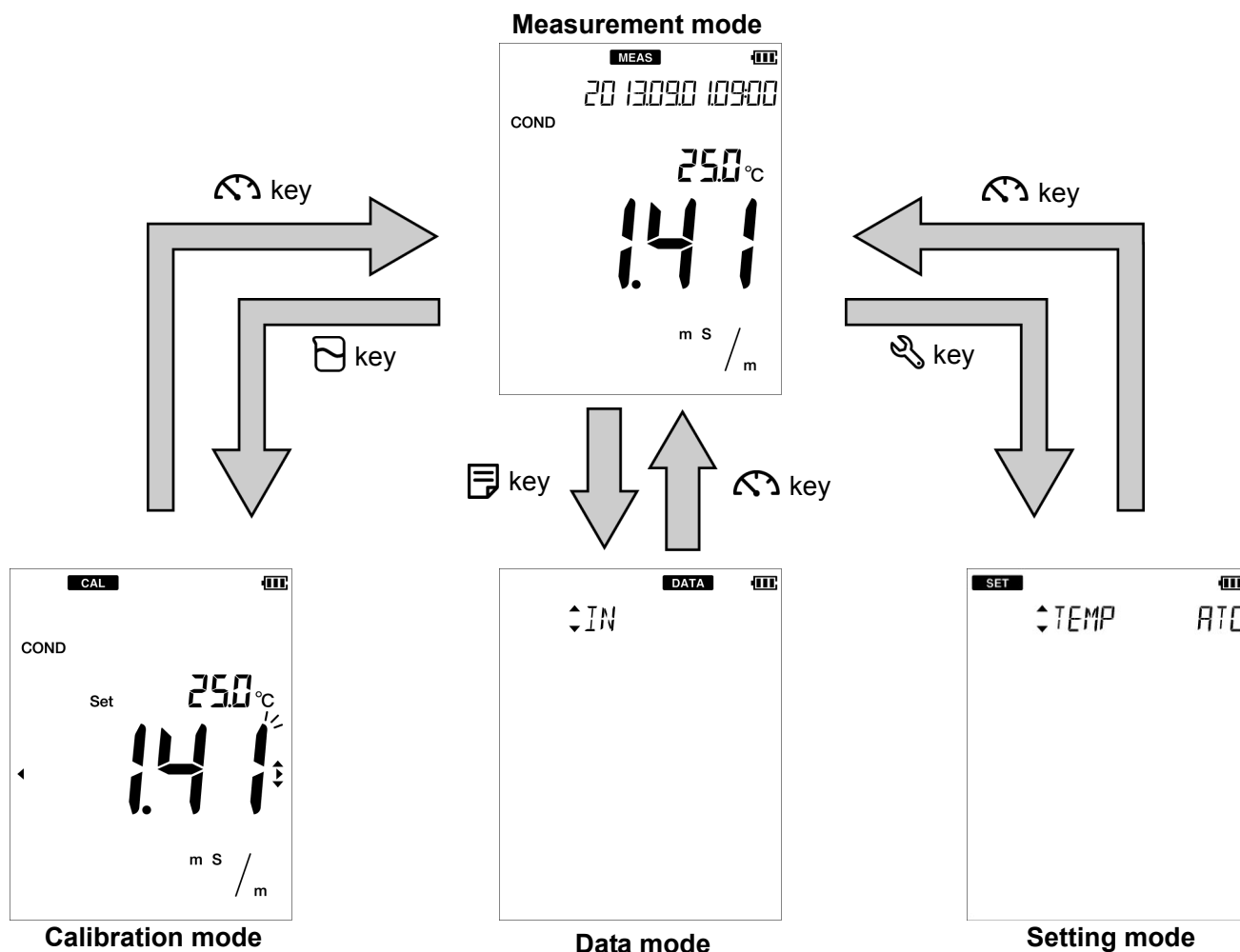

● Changing the measurement parameter



This instrument can measure multiple parameters.

In the measurement mode, the measurement parameter can be changed by pressing the

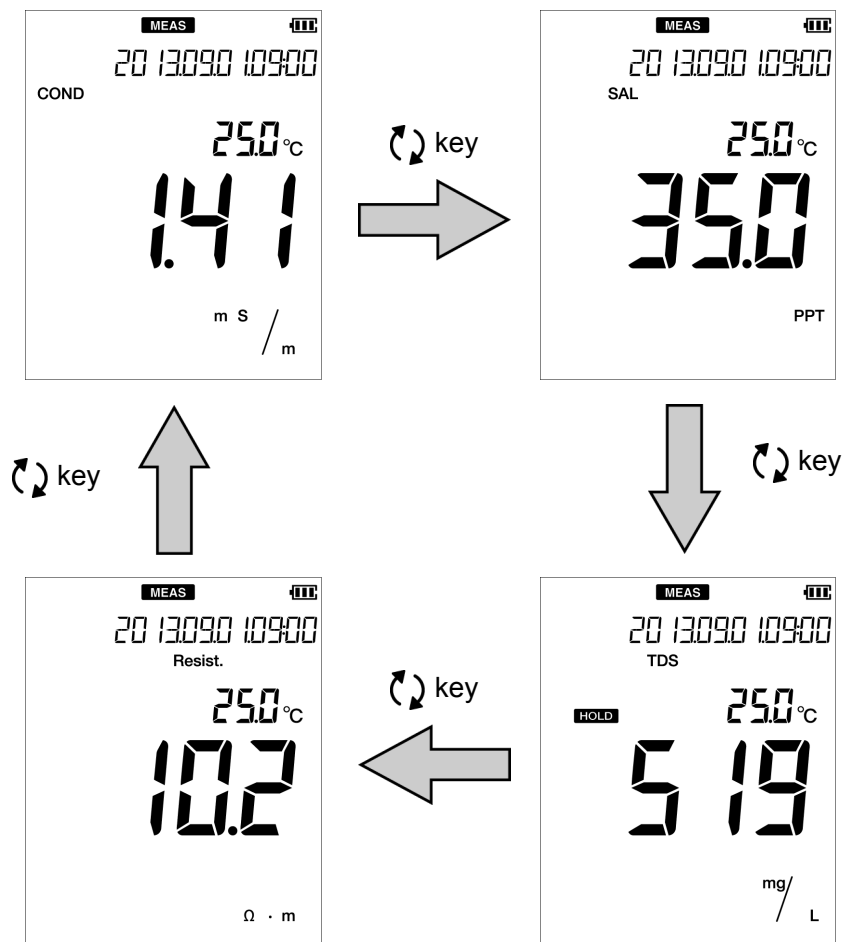
 key.



● Using the backlight

When it is difficult to see the screen in a dark location, you can turn on the backlight by pressing the  key. If the backlight is not operated for 5 minutes, it automatically turns off. To turn it off manually, press the  key again while the backlight is on.

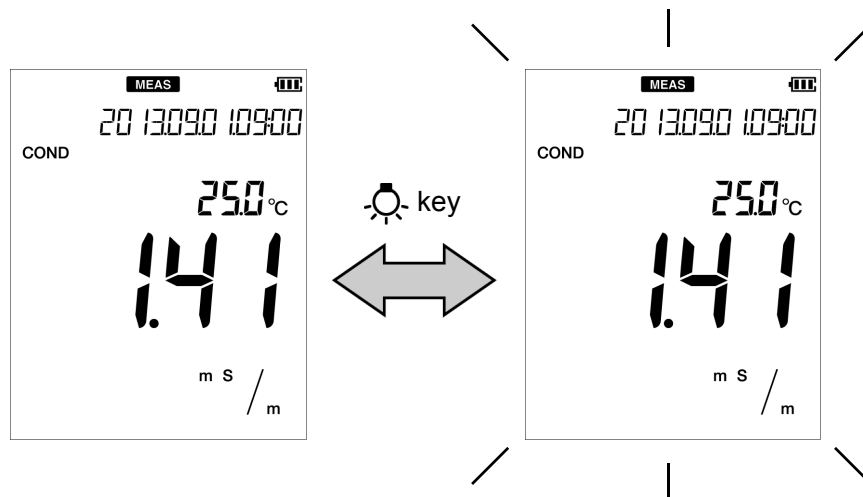

Note

- Turning on the backlight consumes energy and shortens battery life.
 - The backlight becomes unavailable when the battery level becomes low.
-

● Entering numeric values

When entering numeric values to make various settings and set a calibration value, you can change the selected digit using the ◀▶ keys and increment or decrement the value (0 to 9) using the ▲▼ keys.

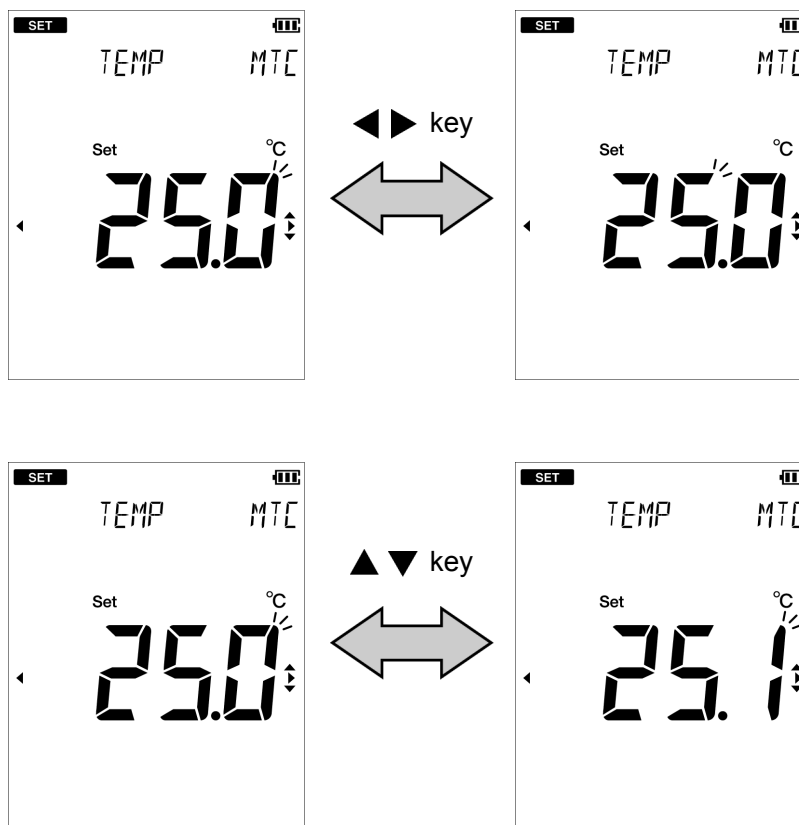

MEMO



Measurement

This section describes the basic method of measurement of each measurement parameters.

■ Preparation	12
● Confirmation before starting measurement	12
● Turning ON the instrument.....	13
• Inserting the batteries	13
• Using the AC adapter (option).....	14
• Pressing the POWER key	14
● Setting the date and time.....	15
● Connecting an electrode	16
■ Conductivity measurement.....	17
● Setting the instrument	18
• Setting the temperature display (default: ATC)	18
• Setting the conductivity unit (default: S/m)	19
• Setting the salinity unit (default: PPT)	20
• Setting the cell constant (default: 1.000×100 m-1)	21
• Setting the temperature conversion (Default: ON, 2.00%/°C)	22
● Performing salinity calibration	23
● Performing measurement	25

■ Preparation

● Confirmation before starting measurement

- Have you prepared the appropriate electrode for the measurement parameter?
⇒ If not, purchase the appropriate electrode.
- Is the prepared electrode in good condition?
⇒ If the responsive part is stained or damaged, it may not be possible to obtain accurate values.
- Have you prepared the appropriate standard solution for the measurement parameter?
⇒ If not, prepare the standard solution by yourself or purchase it.
- Are there any items that should not be wet or stained around the instrument?
⇒ Depending on the operation during measurement, items around the instrument could get wet or stained. Secure sufficient space around the instrument and perform measurement while always paying attention to safety.
- Are there any devices that can be a source of noise?
⇒ Measured values could be affected. Do not use the instrument near such devices.
Always ground devices operated by AC power.

● Turning ON the instrument

• Inserting the batteries

This instrument is operated by batteries. You can use AAA alkaline batteries or AAA Ni-MH rechargeable batteries. Perform the following procedure to insert batteries in the instrument.

1. Turn the knob on the battery cover on the back of the instrument counterclockwise to unlock the battery cover.

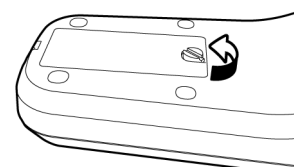

2. Remove the battery cover and set batteries inside.

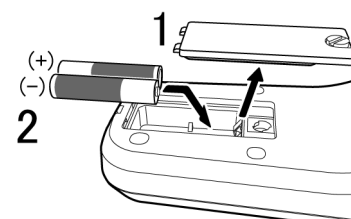

3. Put the battery cover back in.

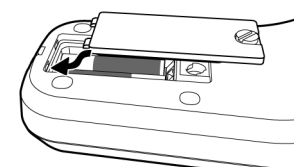

4. Turn the knob on the battery cover on the back of the instrument clockwise to lock the battery cover.

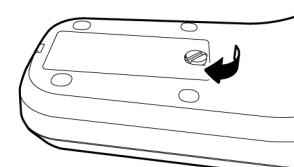

Note

- Do not replace the batteries in a dusty place or with wet hands. Dust or moisture could get inside the instrument, possibly causing instrument malfunction.
- Do not short-circuit a battery.
- Set the + and – side of the battery correctly.
- When the battery has run out or the instrument will not be used for a long time, remove the batteries.
- Of the specified battery types, make sure to use two batteries of the same type.
- Do not use a new battery together with a used battery.
- When using the Ni-MH batteries, do not use a fully charged battery together with an insufficiently-charged battery.

• **Using the AC adapter (option)**

It is possible to use the AC adapter to operate the instrument.

Perform the following procedure to connect AC adapter to the instrument.

The AC adapter is an option. To purchase it, contact your dealer. (Refer to “ Options ” (page 63).)

1. Open the AC adapter cover of the instrument.
2. Insert the AC adapter cable by fitting with the connector socket of in the instrument.
3. Insert AC adapter into the electrical socket.

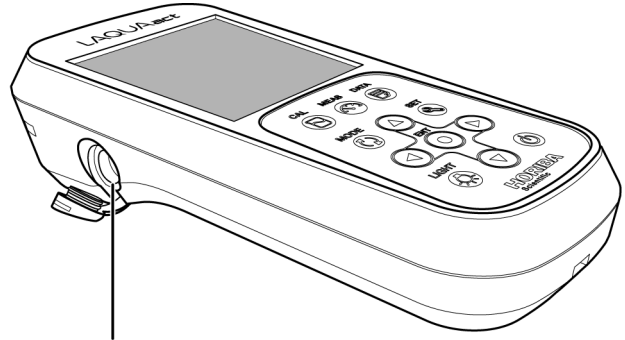

AC adapter connector

Note

- Do not insert the cable with force when the connector does not match the socket.
- When not using the AC adapter, close the AC adapter connector cover.
- While connected to the AC adapter, the instrument does not have the dust-proof and waterproof performance. Dust or moisture could get inside the instrument, possibly causing instrument malfunction.

• **Pressing the POWER key**

After setting the batteries or connecting the AC adapter, press the  key over 1 second. The LCD is fully displayed for 1 second, and the screen displays the measurement mode.

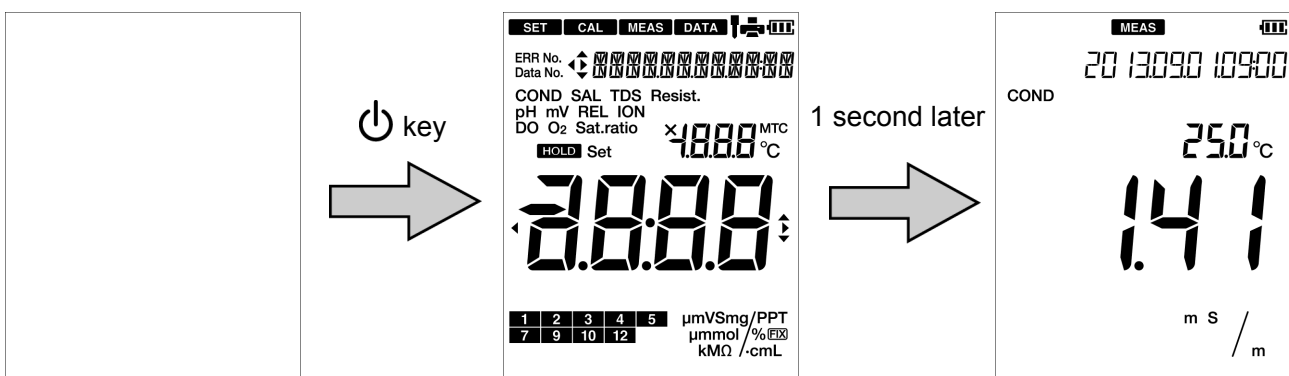





Note





- Do not hold down the  key after the power of the instrument is turned ON.
- Do not use the tip of nail or an object with a sharp end to press keys.

● Setting the date and time

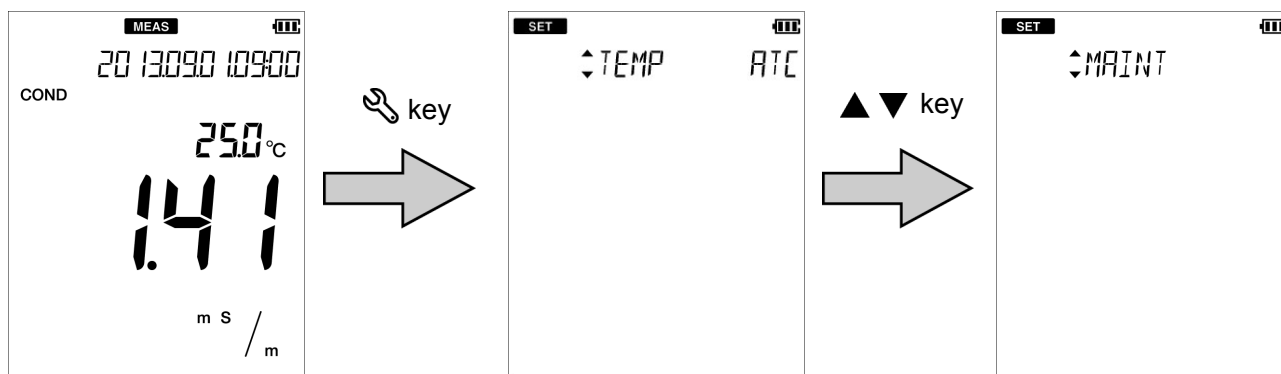
When using the instrument for the first time or after replacing the batteries, set the date and time. After setting, the date and time data is displayed correctly when saving data in the internal memory. If the setting is incorrect, the date and time of saved data becomes incorrect. (Refer to "Displaying saved data" (page 29).)

1. Press the  key to enter the setting mode.
2. Press the   keys to select the "MAINT" (maintenance setting) and then press the  key.



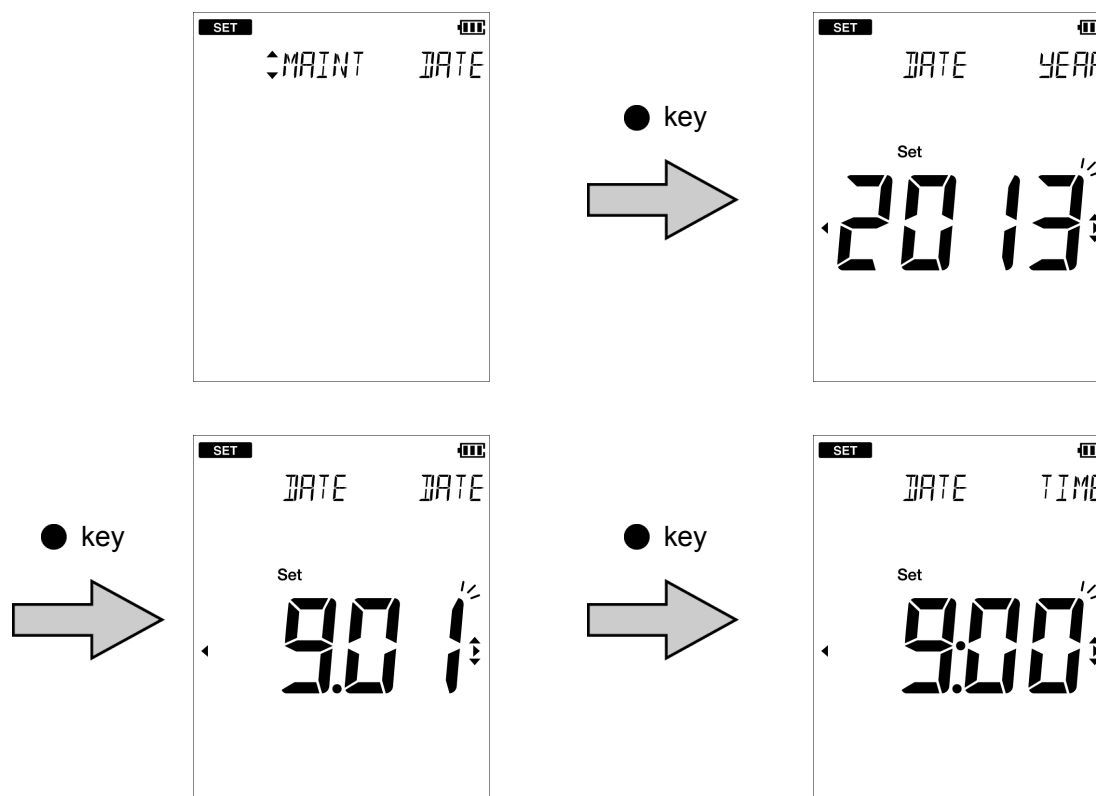

3. Press the   keys to select the "DATE" (date and time setting) and then press the  key.
4. Enter the "YEAR" (current year) and press the  key.
5. In the same way, set the "DATE" (month and date) and "TIME" (hour and minute), in that order.

To return to the setting mode, press the  key.



Tip

To change to the setting again, press the  key to return to the "DATE" (date and time setting) screen. The settings on screen before the  key is pressed are not saved.

● Connecting an electrode

To perform measurement, you must use the proper electrode for measurement items being measured. Recommended electrodes for each measured sample are listed in our catalog and on our website. Refer to them when preparing the appropriate electrode for the sample you want to measure. Use the following procedure to correctly connect the electrode to the instrument.

1. Insert the electrode connector by fitting its groove with the connector socket pin of the instrument.

2. Turn the electrode connector clockwise by following the groove.

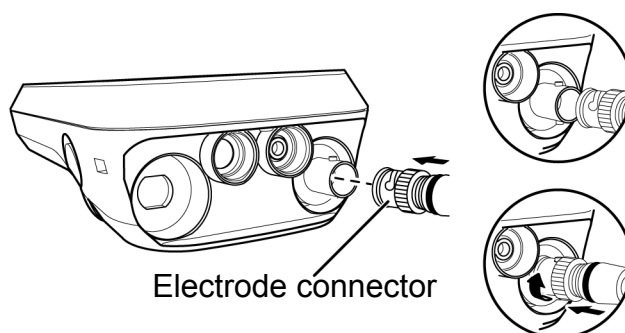

3. Put the connector cover on the connector.

4. Insert the temperature connector into the jack socket on the instrument (only when using a combination electrode equipped with a temperature sensor).

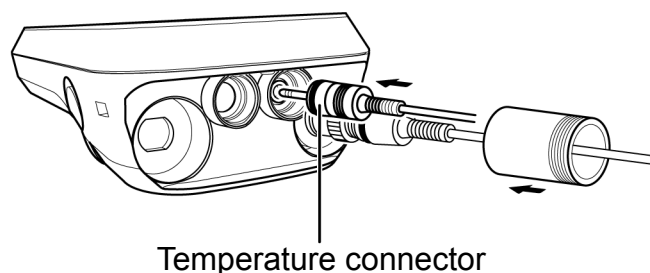

Preparation for measurement is complete.

For details of the measurement operation, refer to the following pages.





■ Conductivity measurement

The conductivity cell can be used to measure the conductivity, salinity, TDS, and resistivity of a sample. Salinity, TDS, and resistivity are calculated from the measured value of conductivity.

Press the  key to select the measurement parameter (“ Changing the measurement parameter ” (page 7)).

The basic steps are the same for all measurement parameters, however, some settings and operations are only valid for specific measurement parameters. Select the settings and perform the steps that show the mark of the parameter you want to measure.

< Examples >

-  : Perform for conductivity measurement.
-  : Perform for salinity measurement.
-  : Perform for resistivity measurement.
-  : Perform for all measurement parameters.

● Setting the instrument

● Setting the temperature display (default: ATC) ALL

When a conductivity cell with a temperature sensor is used, or a conductivity cell without a temperature sensor is used with a temperature electrode, the automatic temperature measurement function can be used. During measurement, the temperature sensor measures the temperature of the sample and displays the result on the instrument. If automatic temperature measurement function is not used, or the temperature connector is not connected to the instrument, the temperature set in the instrument is displayed.

1. Press the  key to enter the setting mode.
2. Select the "TEMP" (temperature setting) and then press the ● key.

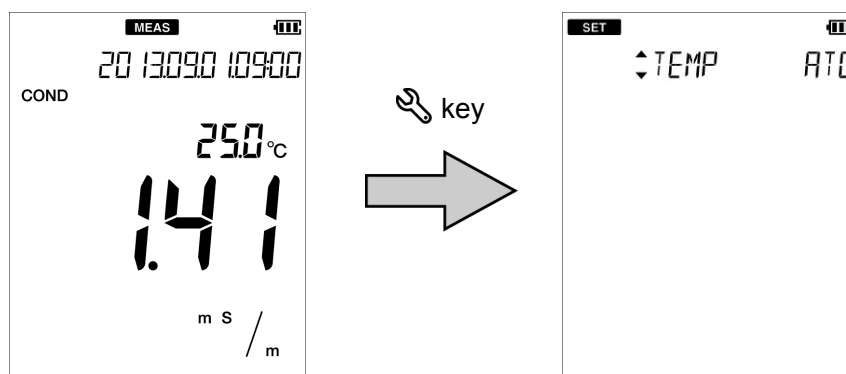



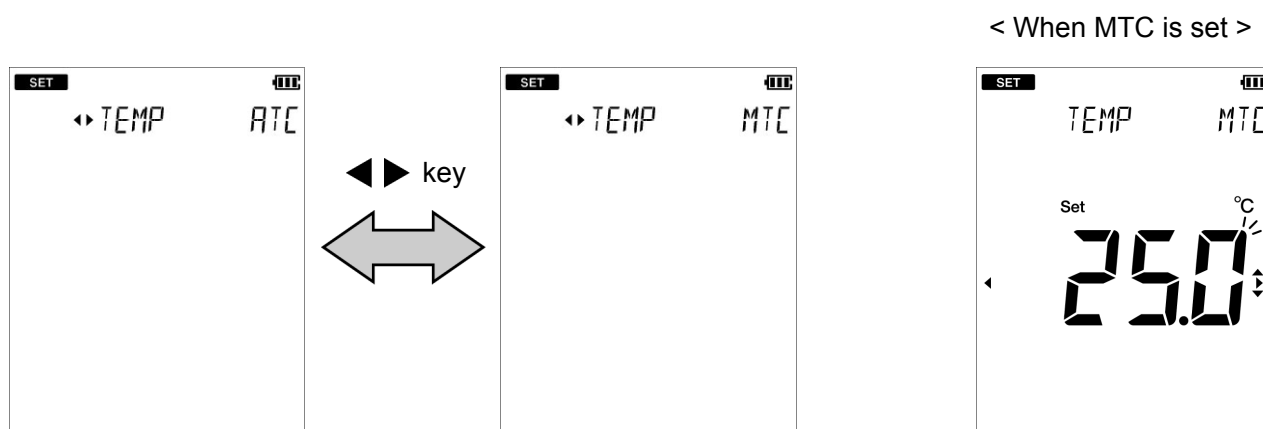

3. Press the ◀▶ keys to select the "ATC" (automatic temperature measurement) or the "MTC" (manual temperature display) and then press the ● key.
4. If you select the "MTC", enter the temperature to be displayed and then press the ● key.



• **Setting the conductivity unit (default: S/m) COND RESIST**

You can select the conductivity unit from three types, S/m, S/cm, mS/cm FIX (fixed at mS/cm). Select the unit depending on your application.

When measuring resistivity, these units correspond to $\Omega \cdot m$, $\Omega \cdot cm$, $\Omega \cdot cm$ (for mS/cm FIX).

1. Press the  key to enter the setting mode.
2. Press the   keys to select the "UNIT (COND)" (conductivity unit setting) and then press the  key.

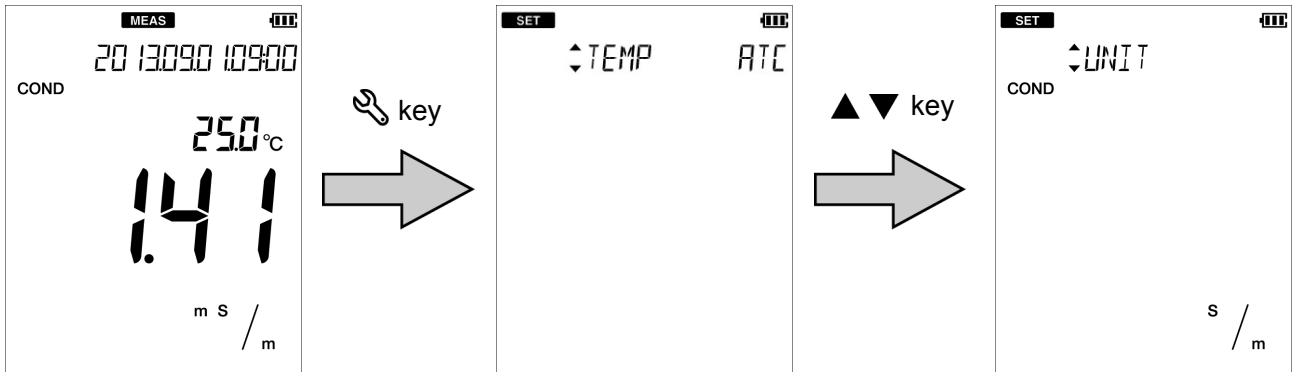



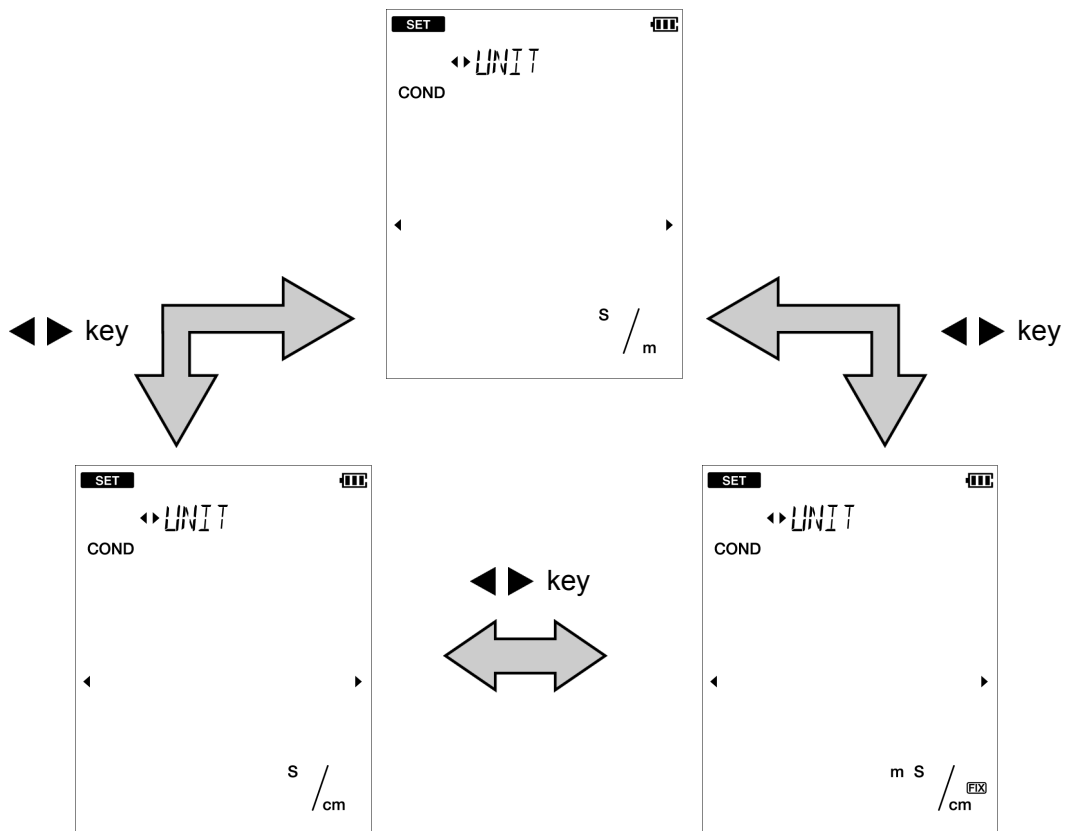

3. Press the   keys to select the unit and press the  key.



• **Setting the salinity unit (default: PPT) (SAL)**

You can select the salinity unit from PPT or %. Select the unit depending on your application.

1. Press the  key to enter the setting mode.
2. Press the   keys to select the "UNIT (SAL)" (salinity unit setting) and then press the  key.

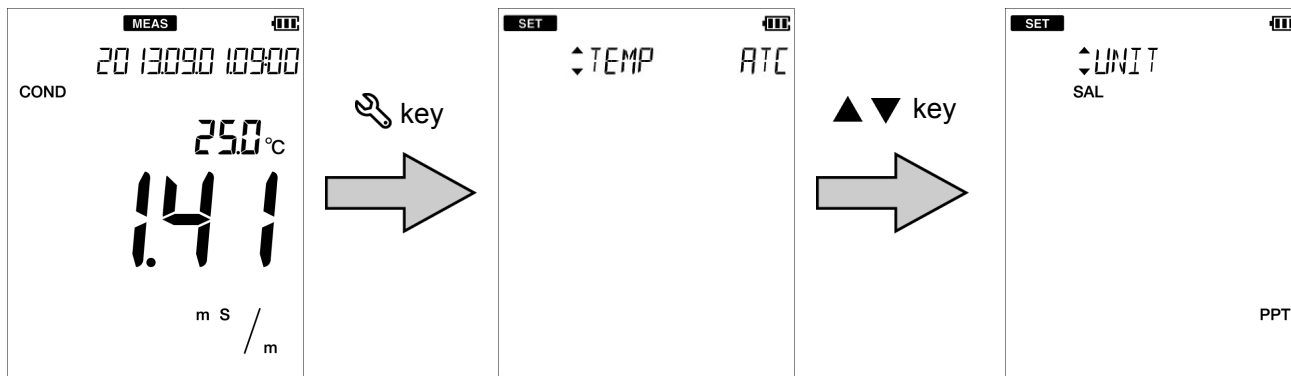



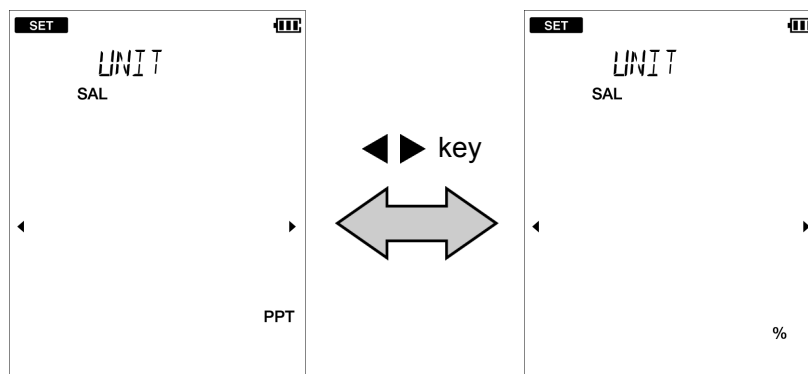

3. Press the   keys to select the unit and press the  key.







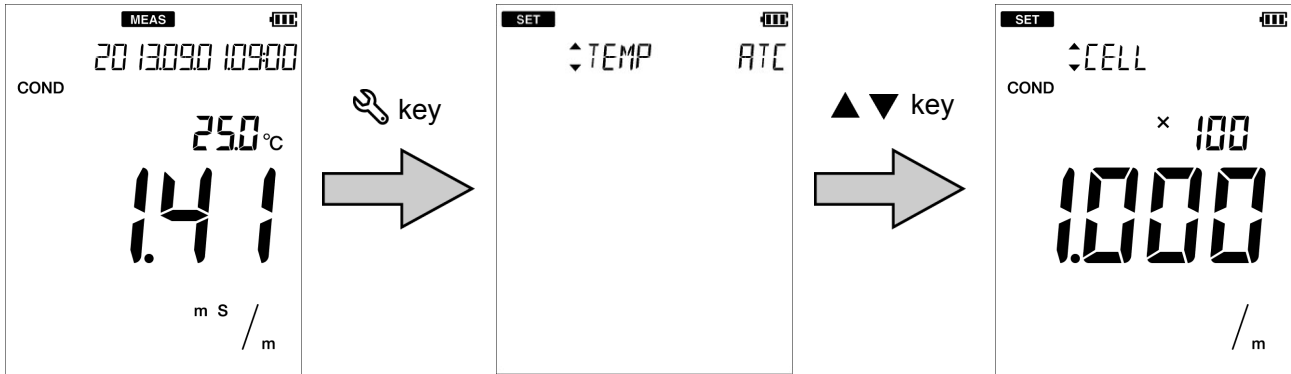

• **Setting the cell constant (default: $1.000 \times 100 \text{ m}^{-1}$)** **ALL**

A cell constant is set for each conductivity cell. To measure conductivity correctly, the cell constant of the conductivity cell must be set in the instrument.

1. Press the  key to enter the setting mode.
2. Press the   keys to select the "CELL" (cell constant setting) and then press the  key.



3. Press the   keys to select the digit number of the cell constant of the conductivity cell and then press the  key.
4. Press the   keys to enter the number of the cell constant of the conductivity cell and then press the  key.

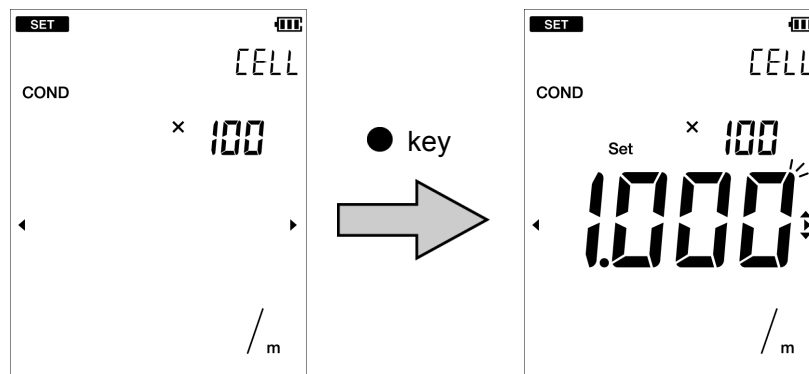





Note

- The unit used for the cell constant corresponds the unit set in “ Setting the conductivity unit (default: S/m) ” (page 19).
- Match the unit indicated on the conductivity cell to the unit set in the instrument.
 $10 \text{ m}^{-1} \Leftrightarrow 0.1 \text{ cm}^{-1}$ $100 \text{ m}^{-1} \Leftrightarrow 1 \text{ cm}^{-1}$ $1000 \text{ m}^{-1} \Leftrightarrow 10 \text{ cm}^{-1}$
- The cell constant may fluctuate depending on conditions of use. Check and calibrate the conductivity cell about once a year (“ Checking and calibrating the conductivity cell ” (page 47)).

• **Setting the temperature conversion (Default: ON, 2.00%/°C)** (ALL)

The measured value of a sample that is not at 25°C can be converted to a value at 25°C. The temperature characteristics of the conductivity vary by sample. To use the temperature conversion function correctly, temperature coefficient (the rate of change per 1°C of the conductivity) must be set for each sample. The setting of “Setting the temperature display (default: ATC)” (page 18) is applied to the sample temperature before the conversion. Be sure to set the temperature display setting to automatic temperature measurement (ATC), or enter the sample temperature correctly.

1. Press the  key to enter the setting mode.
2. Press the   keys to select the "TC" (temperature conversion setting) and then press the  key.

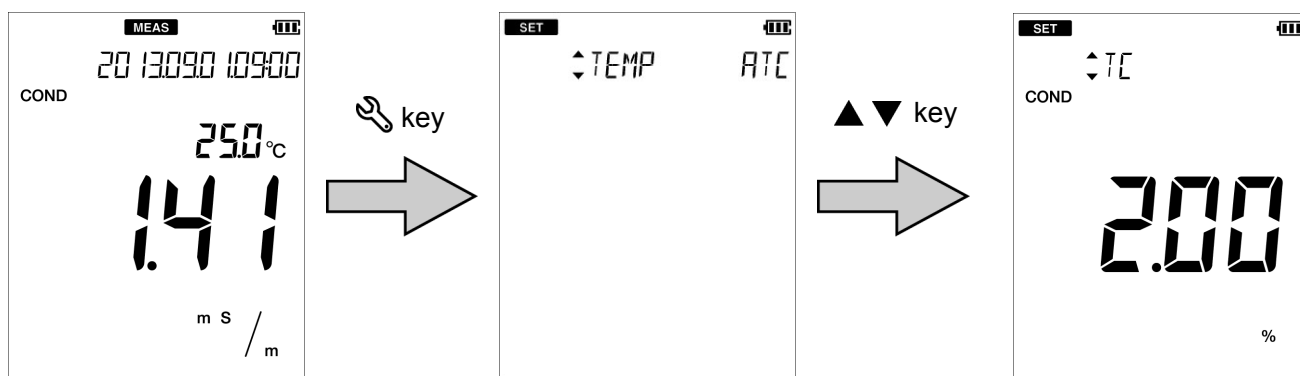

3. Select "ON" to use this function, or select "OFF" not to use it. And then press the  key.

When "ON" is selected, enter the temperature coefficient and then press the  key.

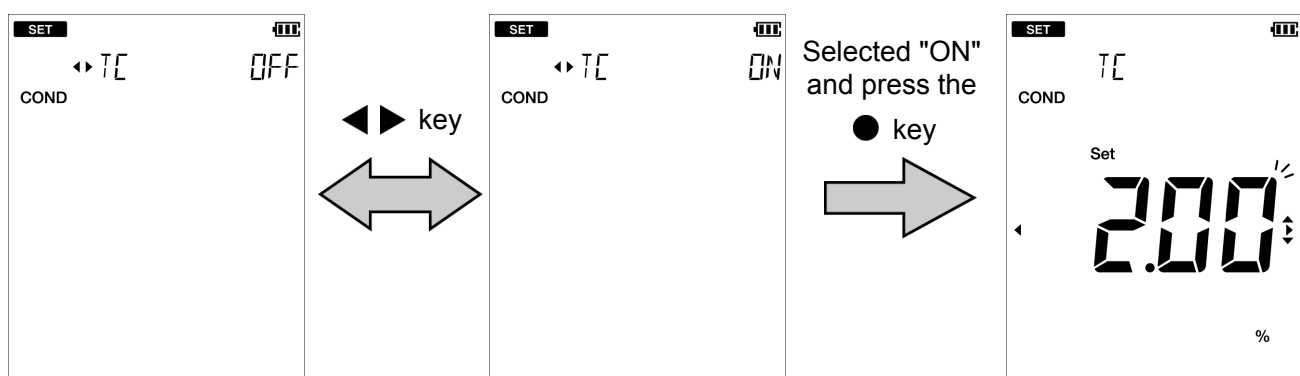



Note

- The temperature coefficient varies by sample. Before using the temperature conversion function, always check the temperature coefficient of the sample and set it in the instrument.
- When the temperature conversion function is used with automatic temperature measurement (ATC), deviations may occur within the accuracy of the temperature sensor. For more accurate measurement, set the temperature setting to manual temperature display (MTC), and measure using a temperature controlled bath.

● Performing salinity calibration SAL

The salinity is calculated from the value of the conductivity, however, one point calibration can be performed using the standard solution. Calibrate at the temperature indicated on the standard solution.

1. Press the  key to change the measurement parameter to salinity.
Refer to “ Changing the measurement parameter ” (page 7).
2. Press the  key to enter the calibration mode, and enter the value of the standard solution to be used for calibration.

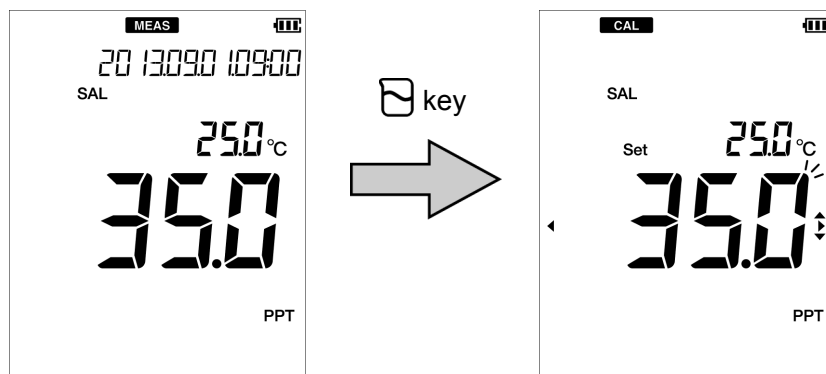

3. Wash the conductivity cell with pure water (or deionized water) and wipe it with filter paper or tissue paper.

Do not touch the black electrode part.



4. Immerse the conductivity cell in the standard solution.

Immerse in the standard solution up to the hole in the lower part of the cell.

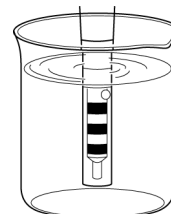

5. While the conductivity cell is immersed in the standard solution, press the  key.

Stabilization judgment starts and the HOLD icon blinks. When the value is stabilized, the HOLD icon changes from the blinking state to the lit state and calibration to the set standard solution value is performed.

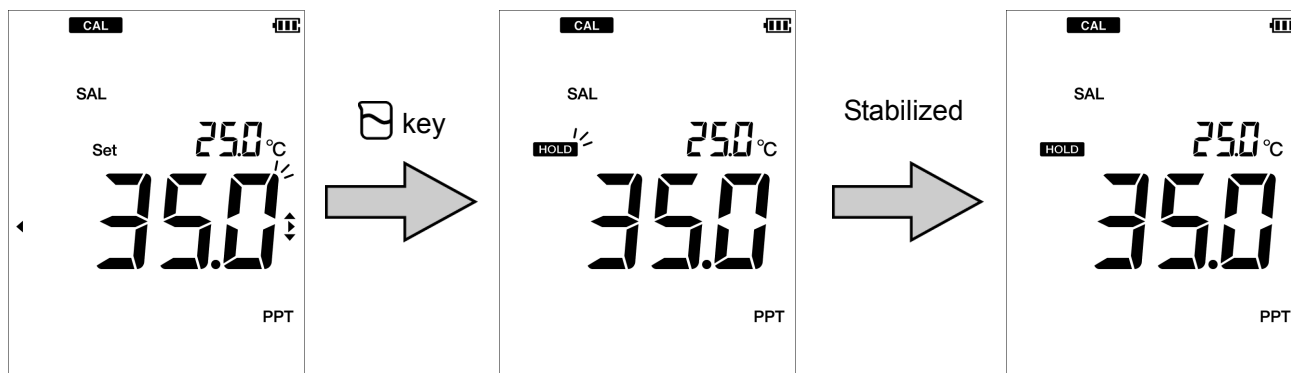

Conductivity measurement

Tip

You can cancel calibration by pressing the  key while the HOLD icon is blinking.

● Performing measurement ALL



Immersing the conductivity cell in the sample solution can perform measurement in the measurement mode. Also, you can use the automatic hold function to perform stability judgment of the measured value.

1. Press the  key to change to the measurement parameter to measure.
2. Wash the conductivity cell with pure water (or deionized water) and wipe it with filter paper or tissue paper.
Do not touch the black electrode part.

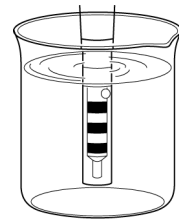

3. Immerse the conductivity cell in the sample solution.
Immerse in the sample solution up to the hole in the lower part of the cell.



4. While the conductivity cell is immersed in the sample solution, press the  key.
Stabilization judgment starts and the HOLD icon blinks. When the value is stabilized, the HOLD icon changes from the blinking state to the lit state and the display is fixed to the measured value at the stable time. Pressing the  key again releases fixing the measured value.



Note

The criteria of stability judgment in the automatic hold measurement are as follows.

- Conductivity: display value change for 10 seconds is less than 3 digit and temperature change is less than 2.0°C
- Salinity: display value change for 10 seconds is less than 1.0 PPT (0.01%) and temperature change is less than 2.0°C
- TDS: display value change for 10 seconds is less than 30 mg/L and temperature change is less than 2.0°C
- Resistivity: display value change for 10 seconds is less than 3 digit and temperature change is less than 2.0°C

MEMO

Using various functions

This section describes functions available in this instrument.

● Saving measurement data in the internal memory	28
● Displaying saved data.....	29
● Deleting all saved data.....	30
● Deleting calibration data.....	31
● Printing measured values and calibration data.....	33
● Transferring saved data to a PC	35
● Operating the instrument from an external device	36
● Using the automatic data save (default: OFF)	37
● Setting the ID number (default: 000).....	39
● Calibrating temperature sensor	40
● Changing the automatic power off setting (default: OFF).....	41
● Performing test printing of the printer unit.....	42
● Resetting to factory default settings	43

● Saving measurement data in the internal memory

Up to 1000 data items measured by the instrument can be stored in the internal memory of the instrument. The measurement data is saved in the internal memory in the measurement mode, except during the automatic hold measurement.

1. While the data to save is displayed, press the  key to enter the data mode.

2. Select "IN" (data saving) and press the ● key.

Saved data is displayed for 2 seconds and the "IN" appears automatically.

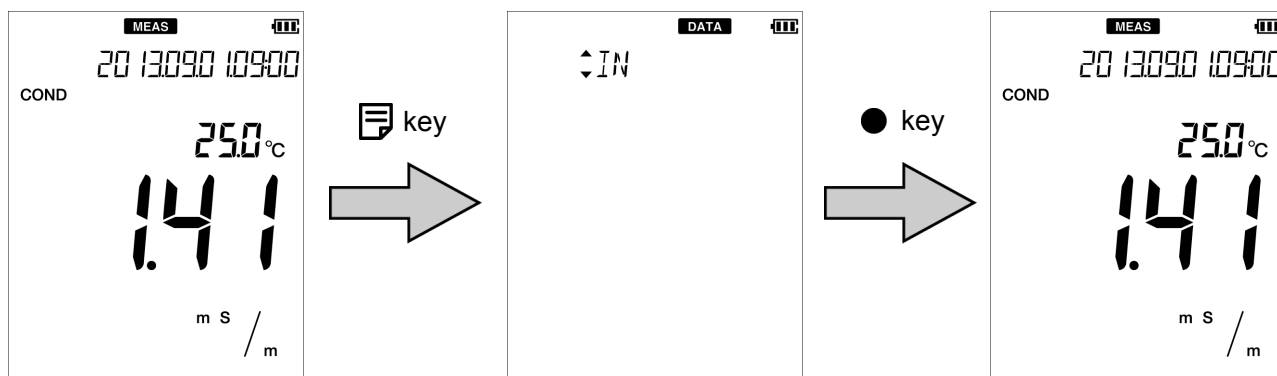









Note

If 1000 data items have already been saved, an error occurs and "ERR No. 0010" is displayed. Copy or transfer necessary data to a PC and delete the data from the memory ("Deleting all saved data" (page 30)).

● Displaying saved data

You can display the data saved in the internal memory.

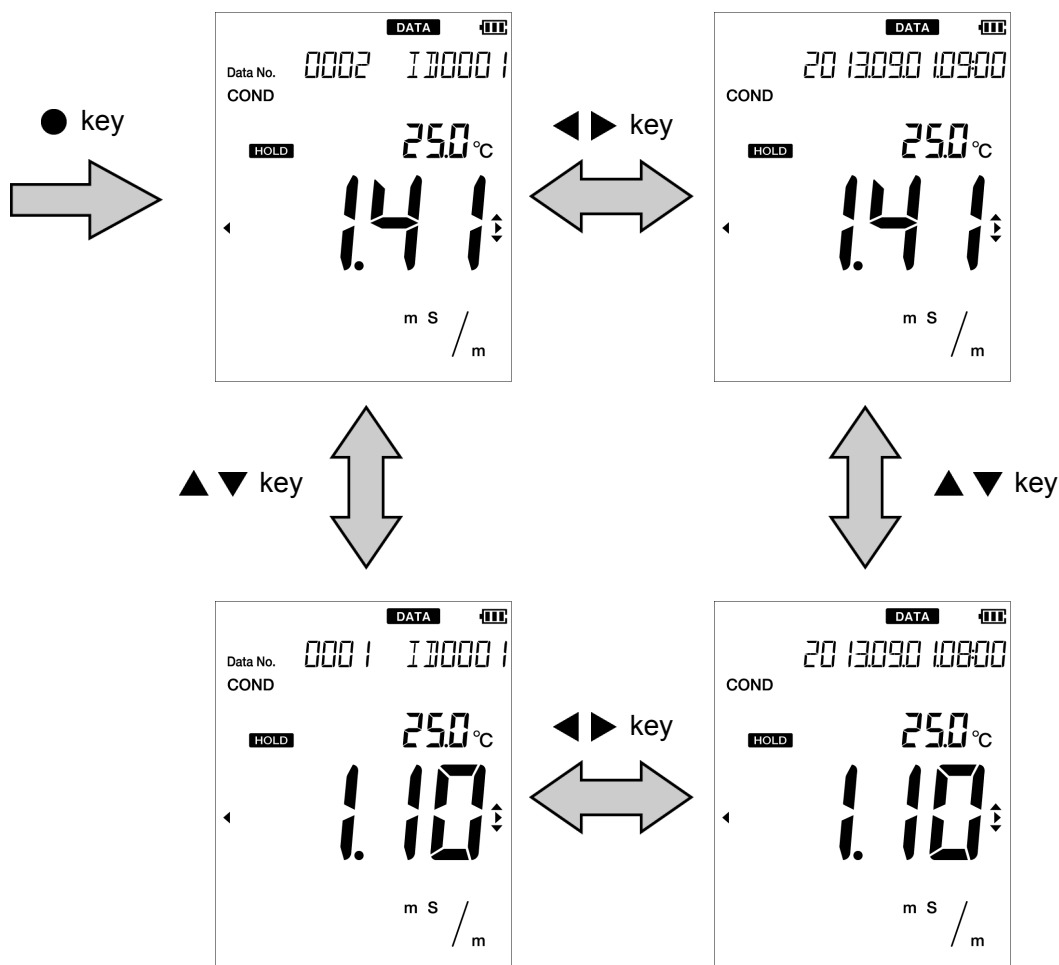
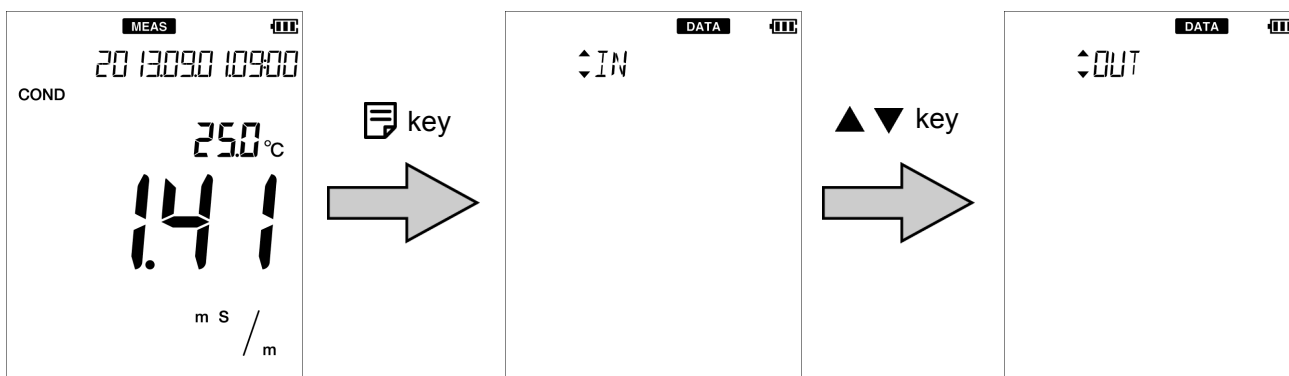

1. Press the  key to enter the data mode.
2. Press the   keys to select "OUT" (display saved data) and then press the  key.

Press the   keys to change the measurement data and press the   keys to change the display between date and data number/sample ID.







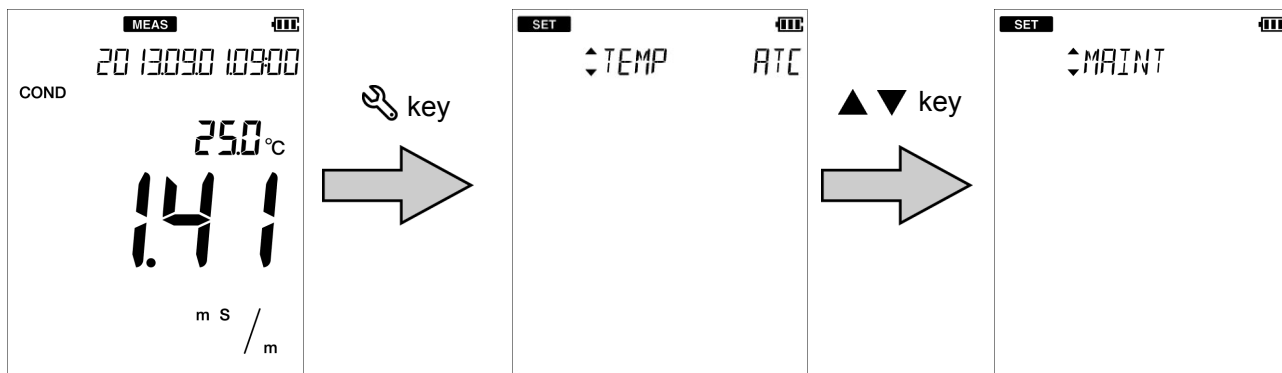

● Deleting all saved data

You can delete all data saved in the internal memory. However, you cannot delete a data individually. Copy or transfer necessary data to a PC for storage.

1. Press the  key to enter the setting mode.
2. Press the   keys to select the "MAINT" (maintenance setting) and then press the  key.



3. Press the   keys to select the "DATCLR" (delete saved data) and then press the  key.
4. Select "YES" to delete the saved data, or select "NO" to cancel deleting it. And then press the  key.
When "YES" is selected, "END" appears after deletes saved data. Press the  key.
To return to the setting mode, press the  key.

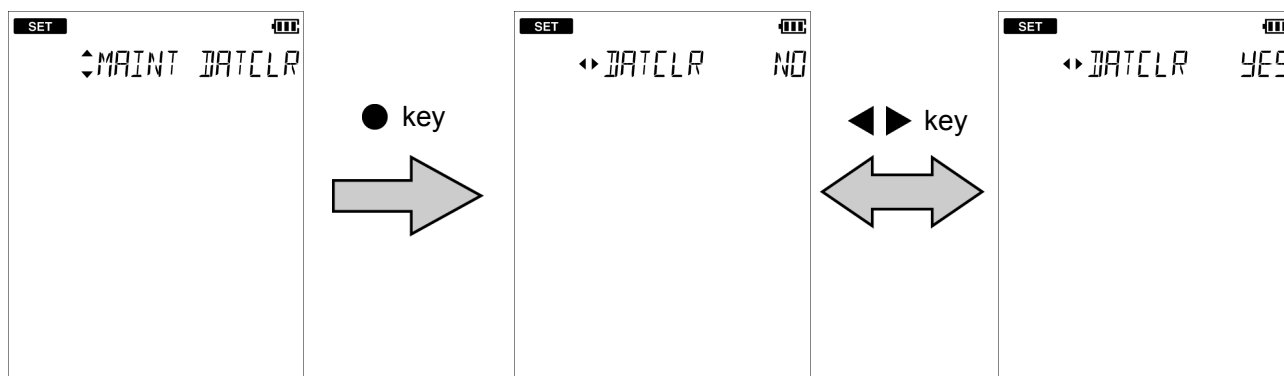



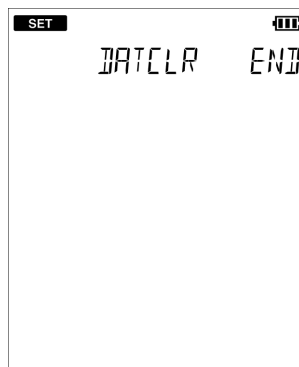
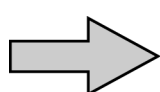

Selected "YES" and press the  key







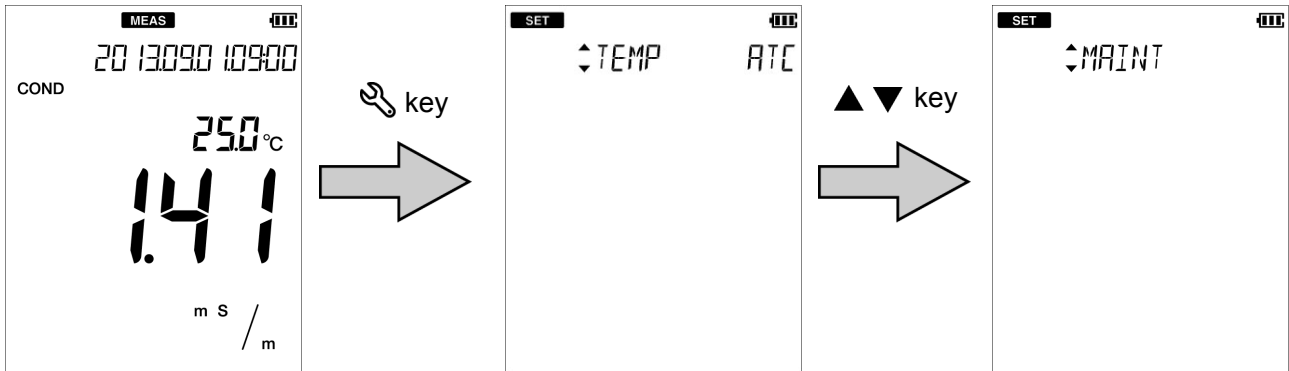

● Deleting calibration data

You can delete the calibration data set in the instrument.

1. Press the  key to enter the setting mode.
2. Press the   keys to select the "MAINT" (maintenance setting) and then press the  key.



3. Press the   keys to select the "CALCLR" (delete calibration data) and then press the  key.
4. Press the   keys to select the measurement parameter to delete and then press the  key.

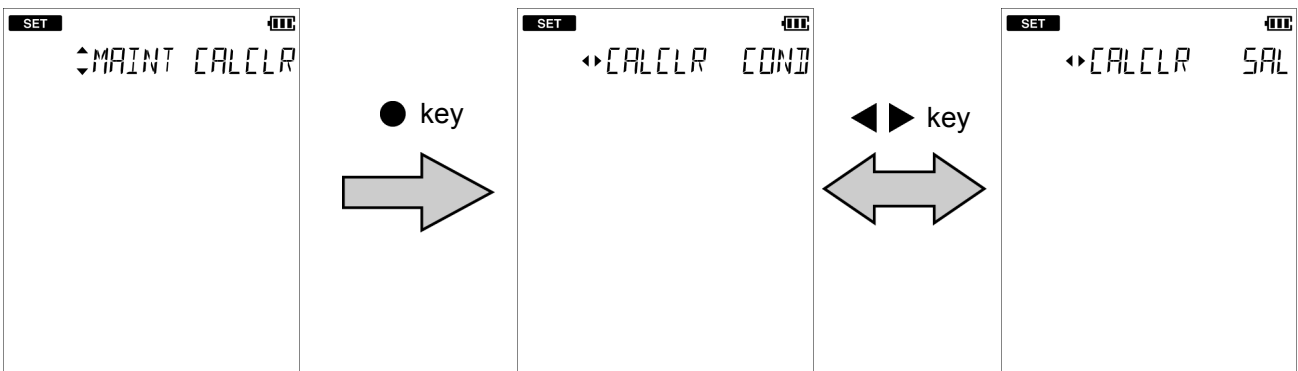

5. Select "YES" to delete the calibration data, or select "NO" to cancel deleting it. And then press the ● key.

When "YES" is selected, "END" appears after deleting calibration data. Press the ● key.

To return to the setting mode, press the ↶ key.

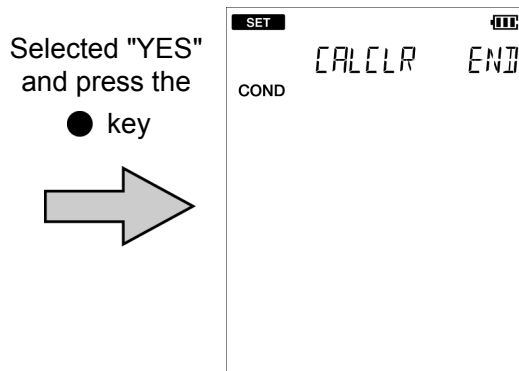
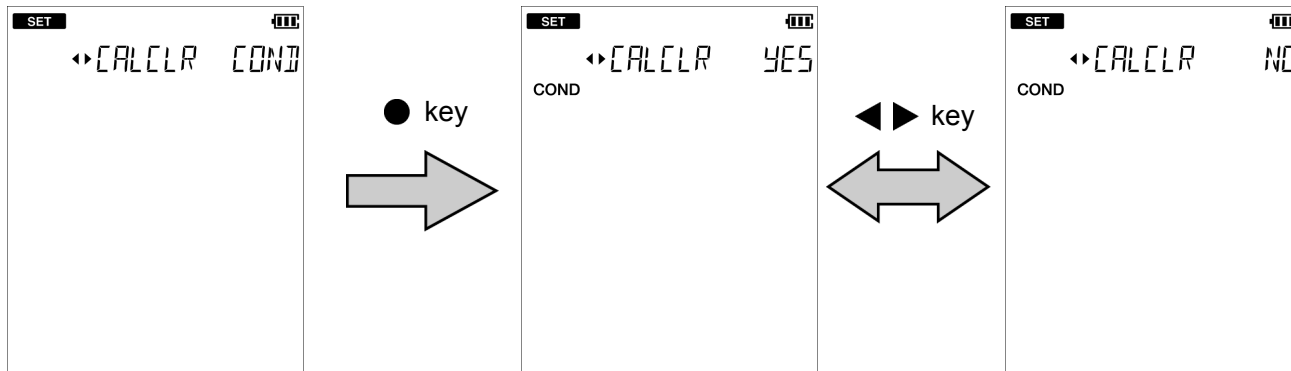

● Printing measured values and calibration data

You can print out the measured value or calibrated value displayed on the instrument, or the measurement data or the calibration data saved in the instrument. If repeatability inspection has been inspected, the inspection data is printed out with the calibration data.

Pressing the ● key starts printing during displaying the data you want to save. Use the printer cable (" Options " (page 63)) to connect the printer unit with the instrument beforehand. If the automatic data memory is set to "ON", you cannot print out in the measurement mode.

Reference

For details of how to display measurement data and calibration data, refer to the respective section.

" Displaying saved data " (page 29)

" Deleting calibration data " (page 31)

The format of the printout is shown on the below when using conductivity.

< Measurement data >

Printout format	Description
Date : 2013/09/01	Measurement date
Time : 09 : 00	Measurement time
Channel : 1	Measurement channel
COND : 1.121 mS/m	Measured value
HOLD : AUTO	HOLD status Hold value: AUTO Not hold value: INST
Temperature : 25.5°C ATC	Temperature value and temperature setting
Sample : 0000	Sample ID number
Inst. model : ES-71	Instrument model
Inst. SN : KL1TSE02	Instrument serial number
CELL :	Cell constant
	1.000×100 m ⁻¹
Temp Coef : 2.00%/°C	Temperature coefficient

Printing measured values and calibration data

< The data saved in internal memory >

Printout format	Description
Memory Num : 0001	Data number
Date : 2013/09/01	Measurement date
Time : 09 : 00	Measurement time
Channel : 1	Measurement channel
COND : 1.121 mS/m	Measured value
HOLD : INST	HOLD status Hold value: AUTO Not hold value: INST
Temperature : 25.0°C MTC	Temperature value and temperature setting
Sample : 0000	Sample ID number
Inst. model : ES-71	Instrument model
Inst. SN : KL1TSE02	Instrument serial number

< Calibration data >

Printout format	Description
Inst. model : ES-71	Instrument model
Inst. SN : KL1TSE02	Instrument serial number
CELL :	Cell constant
1.000×100 m ⁻¹	
Calibration data	
Date : 2013/09/01	Calibration date
Time : 09 : 00	Calibration time
140.9 mS/m :	Calibration result
: 25.0°C ATC	Temperature value and temperature setting
Temp Coef : 2.00%/°C	Temperature coefficient

● Transferring saved data to a PC

By using a serial cable ("Options" (page 63)) to connect the instrument to a PC, you can transfer the saved data to the PC and edit it. Connect the serial connector at the instrument side to the serial port on the PC.

To save and edit data, prepare the software "FD-70".

You can download "FD-70" from our website.

In order to download the software, you need to complete user registration. Refer to the separate sheet "Introduction for user registration" to register as a user.

For details of how to use the "FD-70", refer to the "FD-70" instruction manual, which you can download from our website as well.

The required PC specifications and recommended PC specifications for using the "FD-70" are shown in the following table.

Item	Required PC specifications	Recommended PC specifications
Memory	256 MB or more	512 MB or more
CPU	1 GHz or more	1.6 GHz or more
HDD free space	5 GB or more	10 GB or more
OS	Windows XP (SP3), Windows Vista, Windows 7, or Windows 8	
Display	Super VGA (800 × 600) or more	
Connector	Serial connector (D-Sub 9pin)	

Note

- If you are not using the RS-232C communication, close the connector cover tightly.
- While using the RS-232C communication, the instrument is not dust-proof or waterproof. Do not use the RS-232C communication in a dusty place or with wet hands.

● Operating the instrument from an external device

You can remotely operate the instrument from an external device (ex.PC) via the RS-232C communication. Use the serial cable to connect the serial connector on the instrument side and the serial port on the PC.

When using this function, pay attention to the following points.

- Use the optional serial cable to connect the unit to a PC (“ Options ” (page 63)).
- Make sure that the transfer formats used in the instrument and a PC are the same. When different transfer formats are used, a communication error occurs and the online mode does not start up, and as a result RS-232C communication cannot be performed. Also, when the transfer format is changed, turn OFF the power of the instrument and PC and then reboot them.

The transfer format of the instrument is as follows.

- Baud rate: 2400 bps
- Character length: 8 bits
- Parity: None
- Stop bit: 1 bit

You can download a list of communication commands from our website.

In order to download the list, you need to complete user registration. Refer to the separate sheet "Introduction for user registration" to register as a user.

Note





- If you are not using the RS-232C communication, close the connector cover tightly.
 - While using the RS-232C communication, the instrument is not dust-proof or waterproof. Do not use the RS-232C communication in a dusty place or with wet hands.
-

● Using the automatic data save (default: OFF)

You can automatically save data in the internal memory at the specified interval.

While using this function, the automatic power off setting is disabled.

If the batteries run out while using the automatic data save function, the data saved until just before the batteries run out. Replace the batteries and check the data.

1. Press the  key to enter the setting mode.
2. Press the   keys to select the "AT LOG" (automatic data save) and then press the  key.

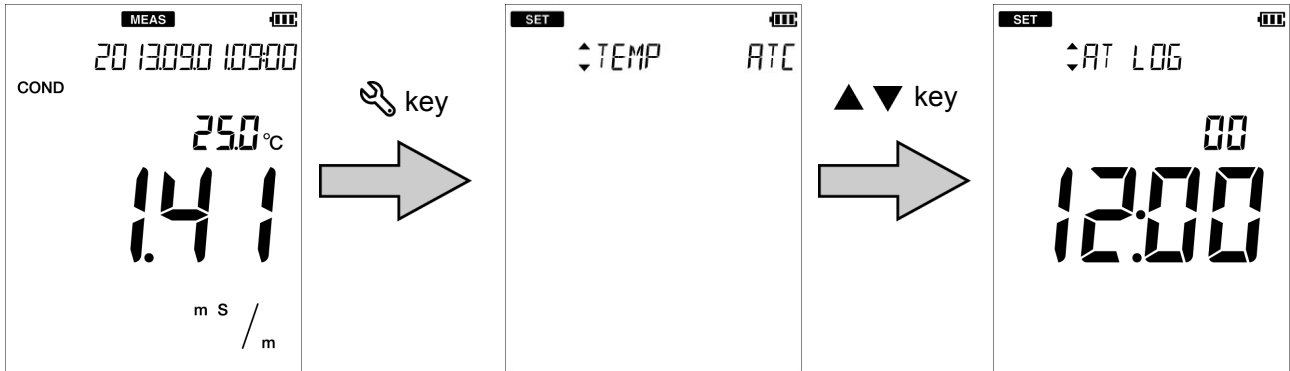

3. Select "ON" to use this function, or select "OFF" not to use it. And then press the  key.

When "ON" is selected, enter the period setting of seconds, hours, and minutes, in that order and press the  key.

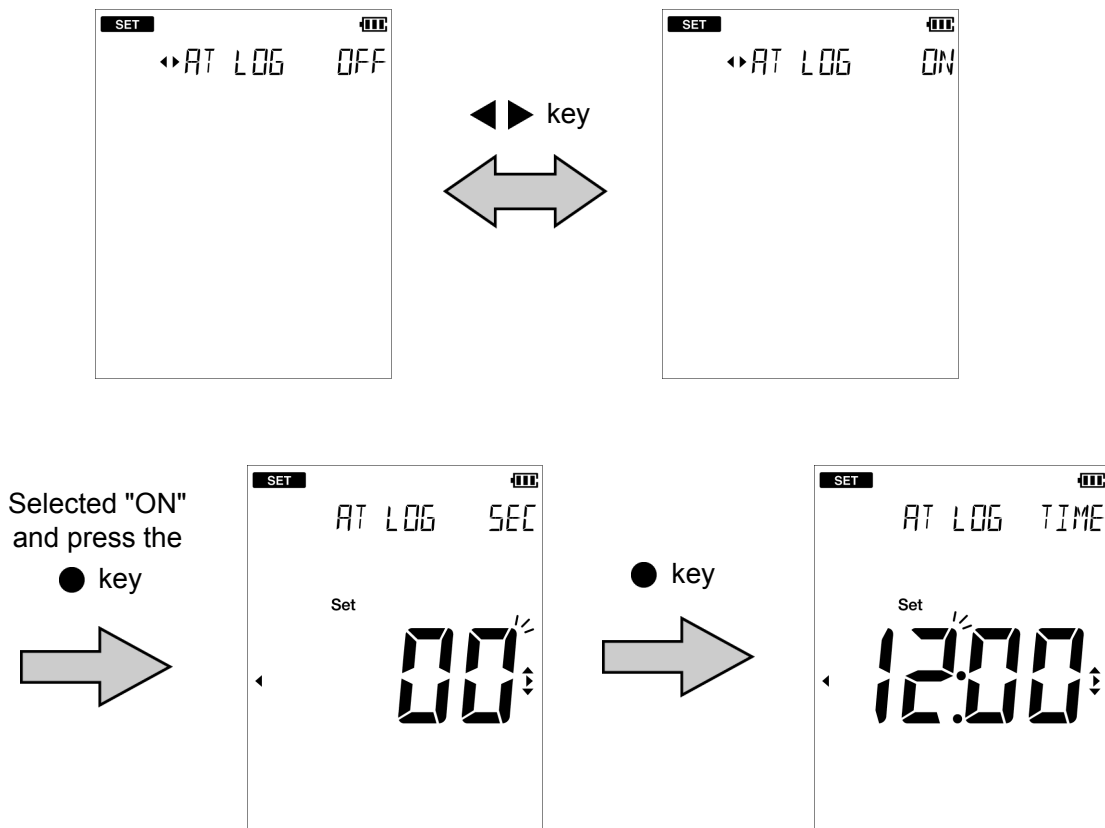

4. Press the  key to enter the measurement mode.

When this setting is "ON", "AUTO LOG", which indicates that the automatic data save function is on, is displayed.



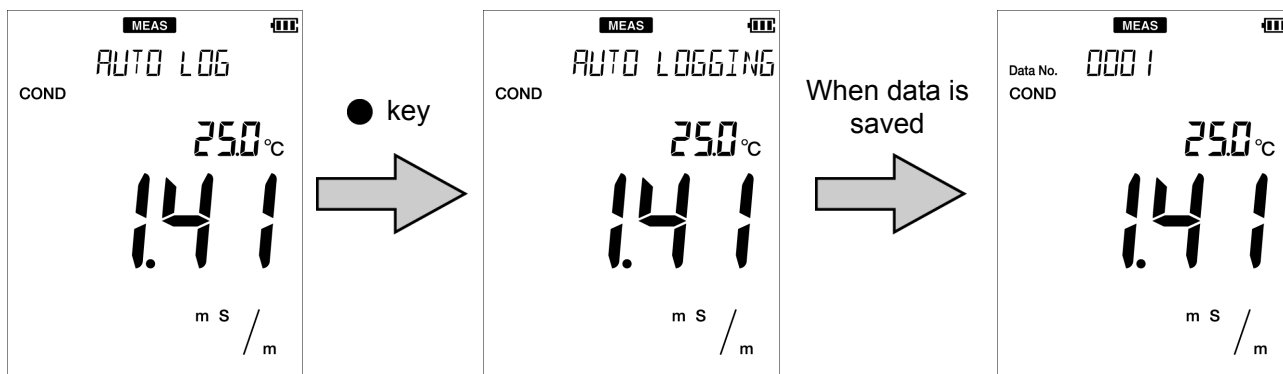

5. Pressing the  key starts saving the data (when the setting is "ON").

Pressing the  key again stops the data saving process. During automatic data saving measurement, data is displayed for one second each time a measurement takes place. When more than 1000 data items are saved, "ERR No. 0010" is displayed and data saving is stopped. When you delete the data, the error is cleared ("Deleting all saved data" (page 30)).



● Setting the ID number (default: 000)

You can set an ID number to differentiate the sample of the data to be saved. When the data is saved in the internal memory, the ID number entered in this setting is saved together with the data.

1. Press the  key to enter the setting mode.
2. Press the   keys to select the "ID" (ID number setting) and then press the  key.

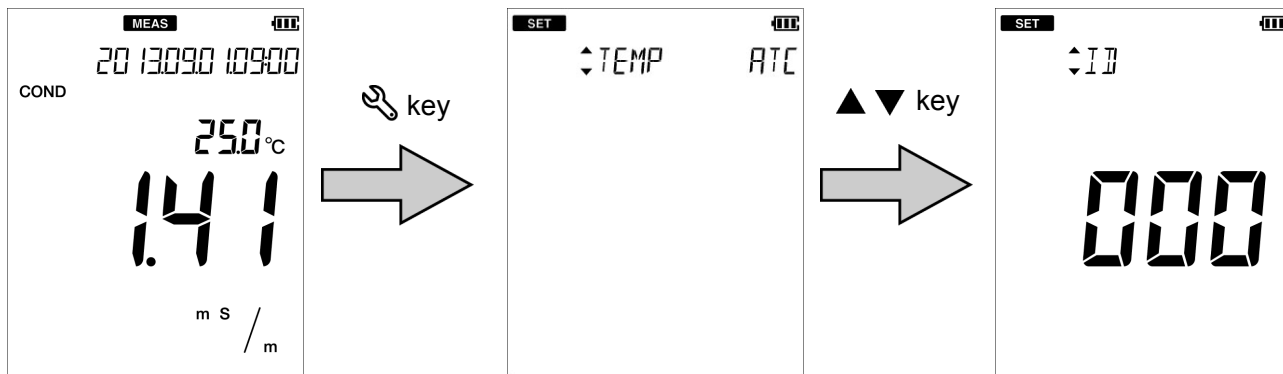



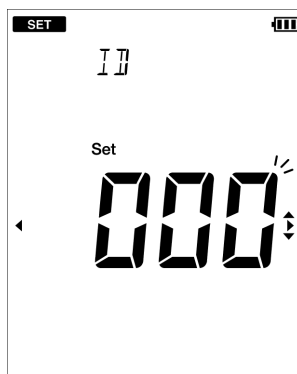

3. Enter the ID number to set and press the  key.
The setting range is 000 to 2999.





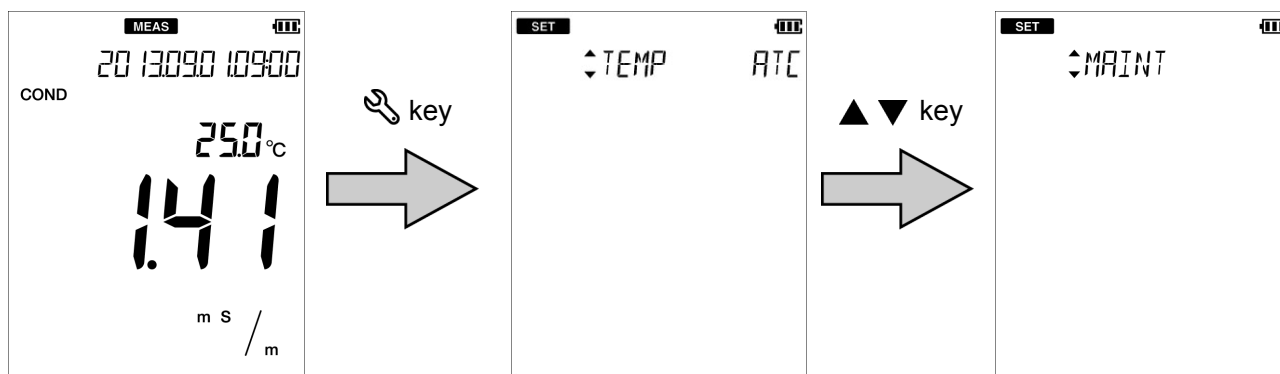

● Calibrating temperature sensor

The temperature sensor or temperature compensation electrode in the combination electrode has $\pm 1^{\circ}\text{C}$ accuracy without calibration. You can use a known temperature solution to calibrate the temperature sensor.

1. Immerse the electrode into the solution until the temperature sensor is immersed.
2. Press the  key to enter the setting mode.
3. Press the   keys to select the "MAINT" (maintenance setting) and then press the  key.



4. Press the   keys to select the "TEMP" (temperature calibration setting) and then press the  key.
5. Enter the set temperature and press the  key.
The temperature sensor is calibrated.
To return to the setting mode, press the  key.

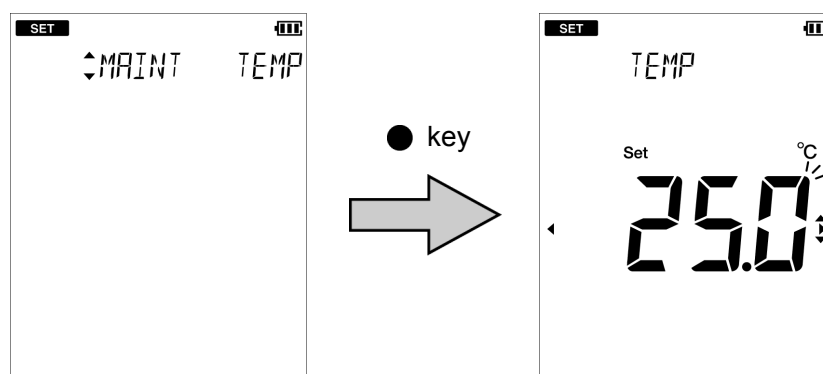





Note

When initializing temperature calibration data, all settings need to be initialized. Perform initialization by referring to "Resetting to factory default settings" (page 43). When initialization is performed, all saved data is deleted. Copy or transfer necessary data to a PC for storage.





● Changing the automatic power off setting (default: OFF)

You can set the instrument to automatically turn OFF when there is no key operation for a certain period of time.

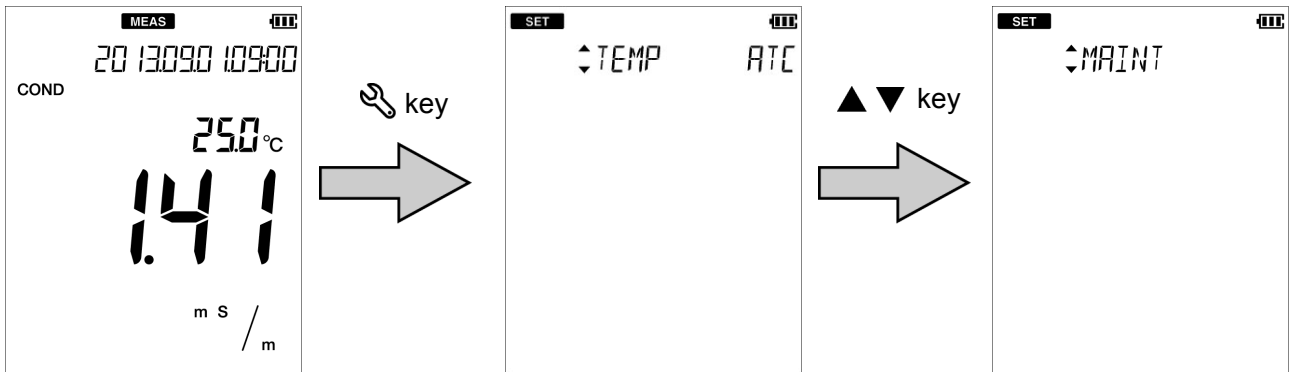
This function is disabled during automatic data memory saving or remote operation using an external device.

1. Press the  key to enter the setting mode.
2. Press the   keys to select the "MAINT" (maintenance setting) and then press the  key.



3. Press the   keys to select the "AT OFF" (automatic power off setting) and then press the  key.
4. Select "ON" to use this function, or select "OFF" not to use it. And then press the  key.

When "ON" is selected, enter the automatic power off time and press the  key. The setting range is 1 min to 30 min.

To return to the setting mode, press the  key.

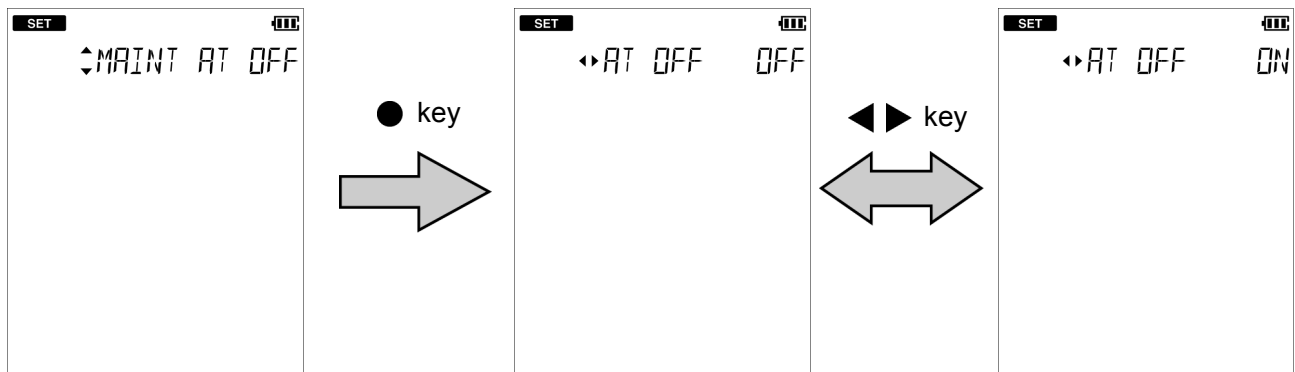

Selected "ON" and press the  key

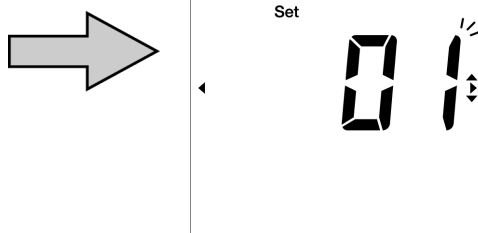



● Performing test printing of the printer unit

In order to check whether the printer unit is operating correctly or there is a printer communication problem, you can perform test printing.





Connect the instrument and a printer correctly and perform the following procedure for test printing. As a result of test printing, if the printout is as shown below, the printer unit is operating correctly.

```

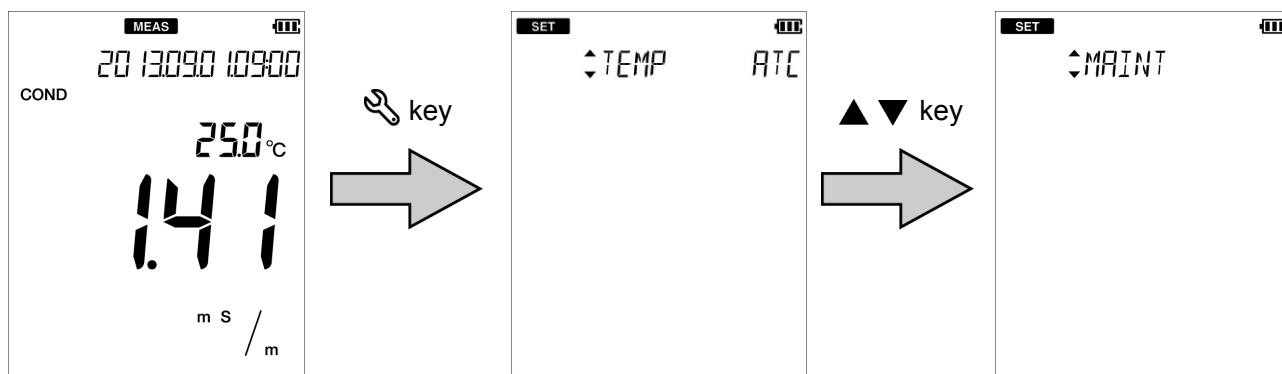
! " # $ % & ' ( ) * + , - . / 0 1 2 3
4 5 6 7 8 9 : ; < = > ? @ A B C D E F G
H I J K L M N O P Q R S T U V W X Y Z [
¥ ] ^ _ ` a b c d e f g h i j k l m n o
p q r s t u v w x y z { | }
    
```

1. Press the  key to enter the setting mode.
2. Press the   keys to select the "MAINT" (maintenance setting) and then press the  key.





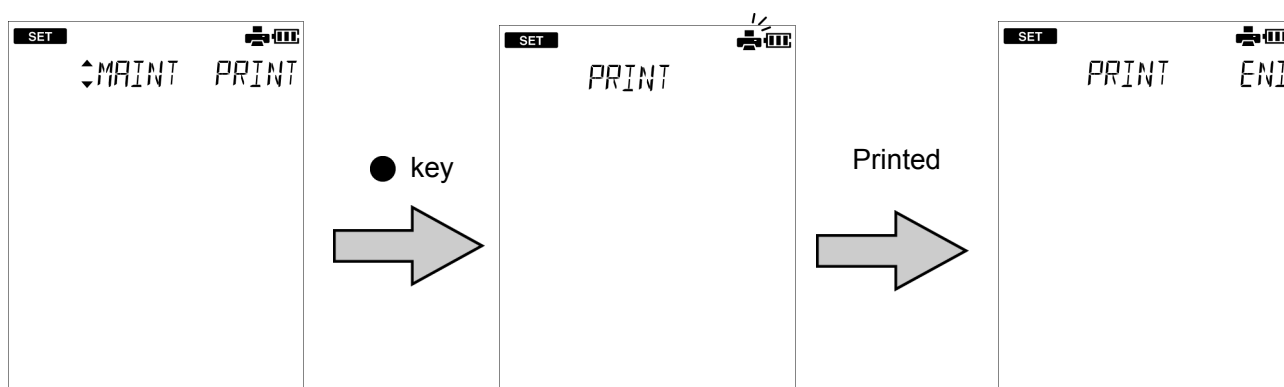

3. Press the   keys to select the "PRINT" (test print) and then press the  key. Printing starts automatically. The printer icon blinks during printing. When printing ends, the printer icon lights and "END" appears. Press the  key. To return to the setting mode, press the  key.





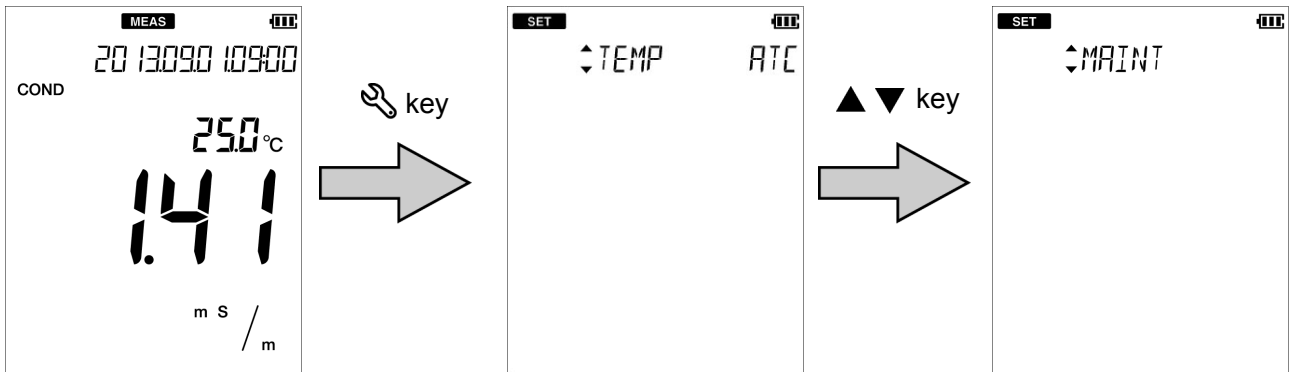

● Resetting to factory default settings

The instrument settings can be reset to the factory default settings. The calibration data is deleted but the data of date and time, and the saved data are not deleted. Make sure there will be no problems before using this function. When this function is used, the temperature calibration data is also initialized.

1. Press the  key to enter the setting mode.
2. Press the   keys to select the "MAINT" (maintenance setting) and then press the  key.



3. Press the   keys to select the "INIT" (initialize) and then press the  key.
4. Select "YES" to initialize the settings to the factory default settings, or select "NO" to cancel initialization. And then press the  key.

When "YES" is selected, "END" appears after the settings are initialized. Press the  key.

To return to the setting mode, press the  key.

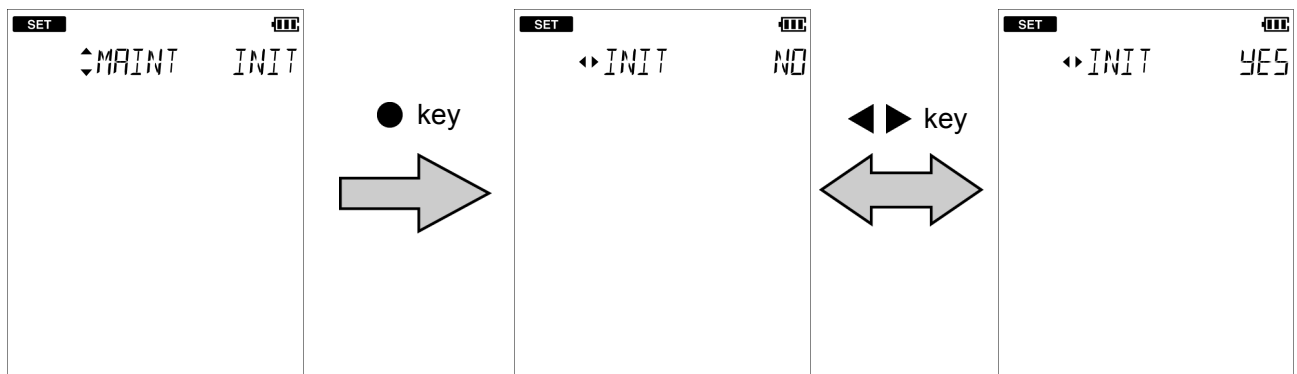

Selected "YES" and press the  key

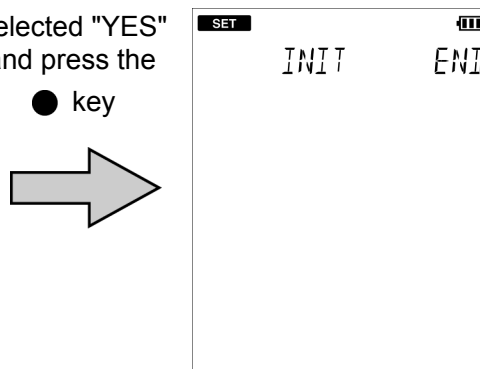

MEMO

Maintenance

This section describes maintenance of the instrument and the electrodes that are used with the instrument. To use them for a long period, perform the described maintenance procedures appropriately.

● Maintenance and storage of the instrument

- If the instrument becomes dirty, wipe it gently with a soft dry cloth. If it is difficult to remove the dirt, wipe it gently with a cloth moistened with alcohol.
- The instrument is made of solvent resistant materials but that does not mean it is resistant to all chemicals. Do not dip the instrument in strong acid or alkali solution, or wipe it with such solution.
- Do not wipe the instrument with a polishing powder or other abrasive compound.

● Environmental conditions for storage

Temperature: 0°C to 45°C

Humidity: under 80% in relative humidity and free from condensation

Avoid the following conditions.

- Dusty place
- Strong vibration
- Direct sunlight
- Corrosive gas environment
- Close to an air-conditioner
- Direct wind

● Maintenance and storage of the conductivity cell

For the detailed procedures for maintaining and storing cells, refer to the instruction manual for each cells. This section describes an overview of the procedures for maintenance and storage to be performed as part of daily use.

• How to clean the cell

Always wash the cell in pure water (or deionized water) after every measurement. When the response is slow or residue from the sample adheres to the cell, use the appropriate method below to clean the cell, and then wash again with pure water (or deionized water).

Type of dirt	Cleaning solution
General	Diluted neutral cleaning solution
Inorganic substance	Ethanol (keep the ethanol away from plastic parts)
Scale that formed during long term storage	A commercially available scale remover (neutral cleansing solution for kitchen use, etc.) diluted by a factor of 100. If this does not remove the scale, use diluted solution that contains oxygen bleach (sodium percarbonate) or chlorine bleach (sodium hypochlorite).

• Daily storage of the cell

If the cell is stored in a dry state, the cell constant will change. Store with the black electrode part immersed in pure water (or deionized water), or with the protective cap filled with pure water (or deionized water) and attached to the cell.

• When the electrode will not be used for a long period

To store the cell for a long period, wash it well and attach the protective cap filled with pure water (or deionized water).

● Checking and calibrating the conductivity cell

If the conductivity cell is used for a long period, the cell constant gradually changes. For this reason, check the conductivity cell about once every three months.

If the result of the check is a deviation of 5% or higher, calibrate the conductivity cell.

- 1. Prepare potassium chloride standard solution to be used for checking and calibrating the conductivity cell. Dry potassium chloride powder for at least two hours at 105°C and let cool in a desiccator.**

The concentration of the standard solution varies depending on the conductivity cell that is used. Refer to the table below.

Cell constant	model	KCl solution	Temp.	Conductivity value	KCl weight	preparative method
1000 m ⁻¹ (10 cm ⁻¹)	3553-10D	0.1 mol/L	25°C	1.286 S/m (12.86 mS/cm)	7.4365 g	Dissolve the weighed KCl, pour into a 1L measuring flask, and add pure water (or deionized water) up to the marked line.
100 m ⁻¹ (1 cm ⁻¹)	3552-10D 9382-10D	0.01 mol/L	25°C	140.9 mS/m (1.409 mS/cm)	0.7440 g	Dissolve the weighed KCl, pour into a 1L measuring flask, and add pure water (or deionized water) up to the marked line.
10 m ⁻¹ (0.1 cm ⁻¹)	3551-10D	0.001 mol/L	25°C	14.7 mS/m (147 μS/cm)	—	Pour 100 mL of the 0.01 mol/L standard solution into a 1L measuring flask, and add pure water (or deionized water) up to the marked line.

- 2. Prepare the standard solution to use the cooled potassium chloride powder as explained above.**
- 3. Wash the conductivity cell with pure water (or deionized water) and wipe it with filter paper or tissue paper.**
Do not touch the black electrode part.

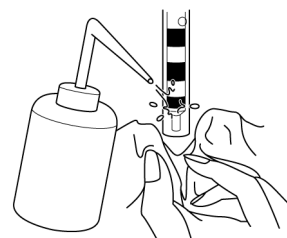

- 4. Immerse the conductivity cell in the prepared standard solution, and read the measured value. If there is a difference of 5% or more between the conductivity of the standard solution and the measured value, perform calibration to use the standard solution.**

If the difference is less than 5%, calibration is not currently needed.

5. Press the  key to enter the calibration mode, and enter the conductivity value of the standard solution.

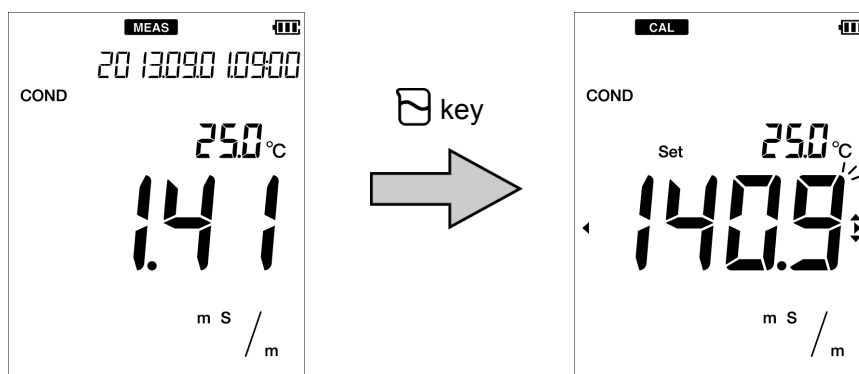

6. Wash the conductivity cell with pure water (or deionized water) and wipe it with filter paper or tissue paper.

Do not touch the black electrode part.

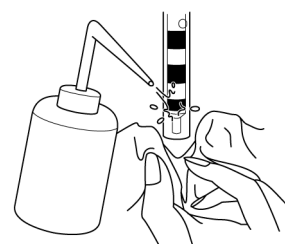

7. Immerse the conductivity cell in the standard solution.

Immerse it the standard solution up to the hole in the lower part of the cell.

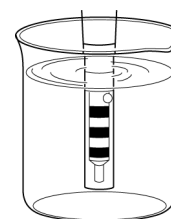

8. While the conductivity cell is immersed in the standard solution, then press the  key.

Stabilization judgment starts and the HOLD icon blinks. When the value is stabilized, the HOLD icon changes from the blinking state to the lit state and calibration to the set standard solution value is performed.

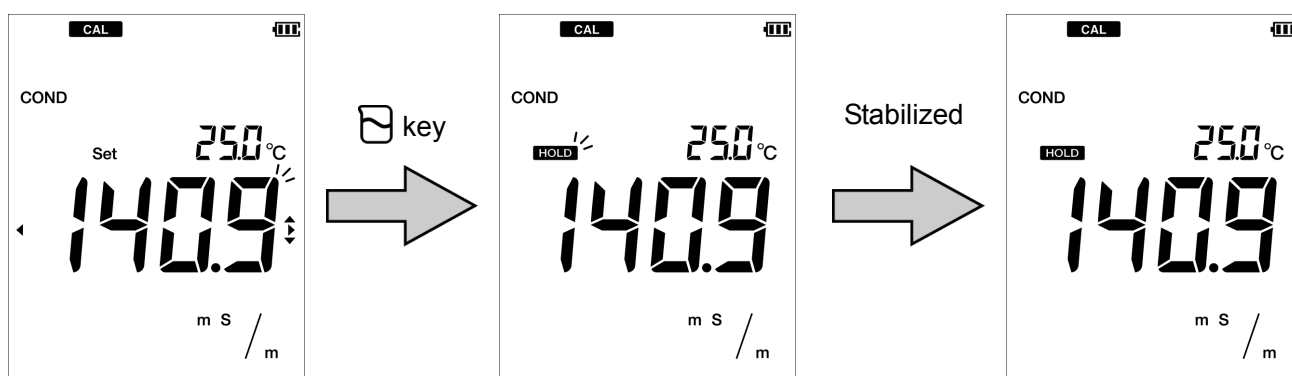

Calibration is complete. Cell constant is set automatically.

Tip

You can suspend calibration by pressing the  key while the HOLD icon is blinking.

How to resolve errors or troubles

This section describes the causes of typical problems and the actions to be taken, including questions frequently asked by customers. Check these before contacting us.

■ When an error message appears

If "ERR No.00XX" appears while you are using the instrument, check the error in the error list below, and check the cause and action to be taken.

ERR No.	Description	Definition of error
0001	Memory error	Data cannot be read from or written to the internal memory.
0002	Empty battery level	The battery level is empty.
0003	Electrode stability error	The electric potential does not stabilize within three minutes.
0009	Printer error	There is a problem with the printer.
0010	Memory full	The number of the data saved has exceeded the limit of the internal memory.
0011	Cell constant is out of range	Cell constant is out of automatic calculation range.

● ERR No.0001 Memory error

Data cannot be read from or written to the internal memory.

Cause	How to solve problem
The instrument does not start properly due to noise or other at power ON.	Remove the batteries, disconnect the AC adapter, and then press the  key.
The defect of the internal IC	Contact your dealer for repair.

● ERR No.0002 Empty battery level

The instrument cannot operate properly because the battery level is empty.

Cause	How to solve problem
The battery level is empty.	Replace the batteries or connect the AC adapter (option).

● ERR No.0003 Electrode stability error

Detected an electrode error because the electrical potential does not stabilize after 3 or more minutes during measurement or calibration.

Cause	How to solve problem
The stability of electrode is affected by the sample solution. (The sample solution is solution with low conductivity, or the pH concentration or temperature change).	Read the value without using the automatic hold function.
The conductivity cell is dirty.	Clean the conductivity cell.
The conductivity cell is broken.	Replace the conductivity cell.
The temperature of the sample solution is fluctuating.	Measure the sample solution after its temperature stabilizes.

● ERR No.0009 Printer error

An error occurred during printer communication.

Cause	How to solve problem
There is a problem with the printer unit connection.	Check the printer connection, and connect the instrument and printer again.
The defect of the printer	Consult your dealer.

● ERR No.0010 Memory full

Attempted to save more than 1000 items of data.

Cause	How to solve problem
Saving more than 1000 items of data is attempted.	The maximum number of savable items of data is 1000. Copy or transfer necessary data to a PC and delete the data from the memory ("Deleting all saved data" (page 30)).

● ERR No.0011 Cell constant is out of range

Cell constant is out of setting range.

Cause	How to solve problem
End of cell life	Replace the conductivity cell.
There is a problem with the standard solution	Use new standard solution.

■ Troubleshooting

This section describes causes and actions to take for problems that customers frequently ask us.

● The indicated value fluctuates

< There is a problem with the electrode >

Cause	How to solve problem
The conductivity cell is dirty.	Clean the conductivity cell.
The conductivity cell is broken.	Replace the conductivity cell.
There are air bubbles on the conductivity cell.	Shake the conductivity cell to remove the air bubbles.

< There is a problem with the instrument >

Cause	How to solve problem
There is a motor or other device causing electrical interference.	Measure at a place where no influence from induction is given. Ground all AC-powered equipment.
The conductivity cell is not connected correctly.	Connect the conductivity cell correctly.

< There is a problem with the sample >

Cause	How to solve problem
Some effects of the sample	Response time may slow down, depending on the properties of the sample solution.

● The response is slow

Cause	How to solve problem
The conductivity cell is dirty.	Clean the conductivity cell.
The conductivity cell is broken.	Replace the conductivity cell.
Some effects of the sample	Response time may slow down, depending on the properties of the sample solution.

● The indicated value does not change/No response

Cause	How to solve problem
The conductivity cell is broken.	Replace the conductivity cell.
The conductivity cell is not connected correctly.	Connect the conductivity cell correctly.
Keys are locked.	Turn off the power, remove the batteries, and then turn on the power again.
The instrument is in HOLD state.	Cancel the HOLD state.
Instrument defect	Consult your dealer.

● The measured value blinks

The measured value blinks when it is out of the measurement range.

Cause	How to solve problem
Sample is out of the measurement range.	Use a sample within the measurement range.
The conductivity cell cable is broken.	Replace the conductivity cell.
Cell constant is not set.	Set the cell constant.
Calibration is not performed or performed incorrectly.	Perform the calibration correctly.
Instrument defect	Check as explained below.

• How to check for instrument defect

Short the metal part of the outer tube to the center pin of the electrode connector of the corresponding channel of the instrument. If the measured value does not blink, the instrument is normal. If the measured value blinks, consult your dealer.

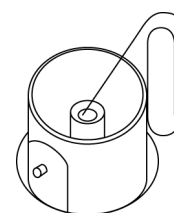

● Repeatability of the measured value is poor

Cause	How to solve problem
Effect of the sample solution	Repeatability becomes poor when the pH of the sample changes over time.
The conductivity cell is dirty.	Clean the conductivity cell.
The conductivity cell is broken.	Replace the conductivity cell.

● The temperature display blinks or is fixed at 25°C

The measured value blinks when it is out of the measurement range.

Cause	How to solve problem
Sample temperature is out of the measurement range.	Set to a temperature within the measurement range.
Temperature connector is not connected correctly.	Connect the temperature connector correctly.
The temperature setting is set to MTC.	Change the setting to ATC.
Operation is incorrect during temperature calibration.	Recalibrate using a solution of known temperature, or return to the factory setting (“ Resetting to factory default settings ” (page 43)).
Instrument defect	Consult your dealer.

● Nothing appears when the power is turned ON

Cause	How to solve problem
Power is not supplied.	Insert batteries or connect the AC adapter (option).
Battery polarity (+, –) is reversed.	Insert the batteries with the polarity (+, –) correctly oriented.
Battery life is low.	Replace the batteries or connect the AC adapter (option).
Instrument defect	Consult your dealer.





● Swelling of operation key sheet

Cause	How to solve problem
Using the instrument at high elevation or other location where the air pressure is different from sea level.	To eliminate the pressure difference between the inside and outside of the instrument, briefly open and then close the AC adapter cover. After opening, correctly close the cover to maintain dust and water proofing.
Instrument defect	Consult your dealer.





● Part of the display is missing

If part of the display is missing, it is the Instrument defect. Contact your dealer.

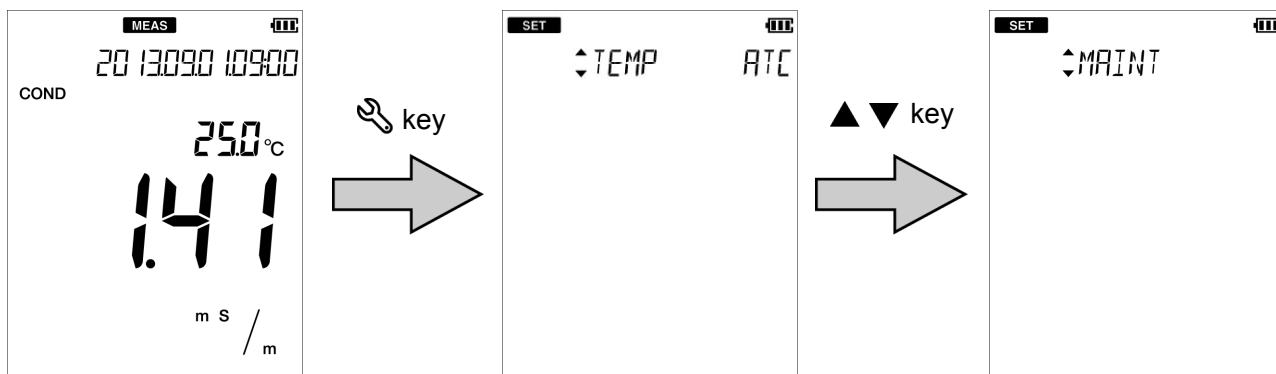
It is possible to check part of the display is missing. The display can be set to full screen display. Follow the steps below to check the display.

1. Press the  key to enter the setting mode.
2. Press the   keys to select the "MAINT" (maintenance setting) and then press the  key.



3. Use the   keys to select the "LCD" (full screen display) and then press the  key.
The display changes to full screen display. Check if part of the display is missing.
To return to the setting mode, press the  key.

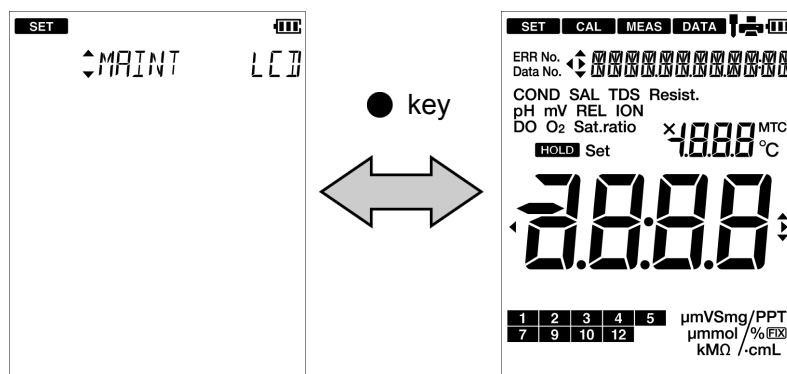

Appendix

This section describes the specifications of the instrument, default settings, measurement principles, and other technical information.

Options for the instrument are also described.

■ Main specifications

Item	Contents
Model	ES-71
Measurement parameters	Conductivity, salinity, TDS, resistivity, temperature
Operating ambient temperature, humidity	0°C to 45°C 80% or less in relative humidity (no condensation)
Power	AAA alkaline batteries (LR03) or AAA Ni-MH rechargeable batteries × 2 AC adapter 100 V to 240 V, 50/60 Hz, 0.37 A (option)
Dimensions	Approx. 67 (80) × 28 (42) × 170 mm (The figures in parentheses are maximum thicknesses.)
Mass	Approx. 270 g (without batteries)

Main specifications

· Specification of each measurement parameters

Measurement parameter	Item	Description
Temperature	Measuring principle	Thermistor method
	Display range	-30.0°C to 130.0°C
	Measuring range	0.0°C to 100.0°C
	Resolution	0.1°C
	Repeatability	±0.1°C ±1 digit
Conductivity	Measuring principle	2 AC bipola method
	Measuring range (Display range)	Cell constant 100 m ⁻¹ : 0.000 mS/m to 20.00 S/m Cell constant 10 m ⁻¹ : 0.0 μS/m to 2.000 S/m Cell constant 1000 m ⁻¹ : 0.00 mS/m to 200.0 S/m
	Resolution	0.05% of full scale
	Repeatability	±0.5% ±1 digit of full scale
Salinity	Measuring principle	Conversion from conductivity value
	Measuring range (Display range)	0.00% to 4.00%
	Resolution	0.01%
TDS	Measuring principle	Conversion from conductivity value
	Measuring range (Display range)	0.01 mg/L to 100 g/L
	Resolution	0.01 mg/L
Resistivity	Measuring principle	Conversion from conductivity value
	Measuring range (Display range)	Cell constant 100 m ⁻¹ : 0.00 Ω·m to 200.0 kΩ·m Cell constant 10 m ⁻¹ : 0.0 Ω·m to 2.000 MΩ·m Cell constant 1000 m ⁻¹ : 0.000 Ω·m to 20.00 kΩ·m
	Resolution	0.05% of full scale
	Repeatability	±0.5% ±1 digit of full scale

● Table of conductivity cell range

• Unit: S/m

Range	Cell constant		
	1000 m ⁻¹	100 m ⁻¹	10 m ⁻¹
20.0 to 199.9 S/m			
2.00 to 19.99 S/m			
0.200 to 1.999 S/m			
20.0 to 199.9 mS/m			
2.00 (0.00) to 19.99 mS/m			
0.200 (0.000) to 1.999 mS/m			
0.0 to 199.9 μS/m			

• Unit: S/cm

Range	Cell constant		
	10 cm ⁻¹	1 cm ⁻¹	0.1 cm ⁻¹
0.200 to 1.999 S/cm			
20.0 to 199.9 mS/cm			
2.00 to 19.99 mS/cm			
0.200 to 1.999 mS/cm			
20.0 (0.0) to 199.9 μS/cm			
2.00 (0.00) to 19.99 μS/cm			
0.000 to 1.999 μS/cm			

● **Table of conductivity cell range (resistivity range)**

• Unit: $\Omega \cdot m$

Range	Cell constant		
	1000 m ⁻¹	100 m ⁻¹	10 m ⁻¹
0.200 to 1.999 M $\Omega \cdot m$			
20.0 to 199.9 k $\Omega \cdot m$			
2.00 to 19.99 k $\Omega \cdot m$			
0.200 to 1.999 k $\Omega \cdot m$			
20.0 (0.0) to 199.9 $\Omega \cdot m$			
2.00 (0.00) to 19.99 $\Omega \cdot m$			
0.000 to 1.999 $\Omega \cdot m$			

• Unit: $\Omega \cdot cm$

Range	Cell constant		
	10 cm ⁻¹	1 cm ⁻¹	0.1 cm ⁻¹
20.0 to 199.9 M $\Omega \cdot cm$			
2.00 to 19.99 M $\Omega \cdot cm$			
0.200 to 1.999 M $\Omega \cdot cm$			
20.0 to 199.9 k $\Omega \cdot cm$			
2.00 (0.00) to 19.99 k $\Omega \cdot cm$			
0.200 (0.000) to 1.999 k $\Omega \cdot cm$			
0.0 to 199.9 $\Omega \cdot cm$			

■ Instrument default settings

Measurement parameter	Item	Selection item/Setting range	Default values
Common	Temperature setting	Automatic (ATC)/ Manual (MTC)	Automatic (ATC)
	Temperature input value	0.0°C to 100.0°C	25.0°C
	Auto power off	ON/OFF	OFF
	Auto power off time	1 min to 30 min	30 min
	Sample ID	000 to 2999	000
	Auto data memory	ON/OFF	OFF
	Auto data memory time	2 seconds to 24 hours	2 seconds
Conductivity	Cell constant	0.700 to 1.300 (10 m ⁻¹ , 100 m ⁻¹ , 1000 m ⁻¹)	1.000 (100 m ⁻¹)
	Temperature conversion	ON/OFF	ON
	Temperature coefficient	0.00%/°C to 10.00%/°C	2.00%/°C
	Unit	S/m, S/cm, mS/cm FIX	S/m
Salinity	Unit	PPT, %	PPT

■ Technical note

● Conductivity measurement

Conductivity is an index that expresses the ease with which electric current flows through a material. Conductors are categorized either as electron conductors (such as metals and other substances which use free electrons to conduct electricity) or ion conductors (such as electrolytic solution or fused salt, which use ions to conduct electricity). This section describes the kind of conductivity that pertains to ions, especially the conductivity of electrolytic solution that uses water as the solvent. As shown in figure, two pole plates with an area "a" are positioned parallel to each other, separated by distance "l". Then solution is poured into the cell until it is full and alternating current is run between the plates. Each positive and negative ion in the solution will migrate toward the oppositely charged pole. The result is that current flows through the solution by means of ion conductivity. When this occurs, resistance "R" is in inverse proportion to the area "a" of the pole plates, as is the case with metal and other conductors, and is proportional to the distance "l" between the two pole plates. These relationships are expressed by equation ①, below.

$$R = r \times \frac{l}{a} = rJ \dots\dots\dots ①$$

R: Resistance (Ω) r: Resistivity (Ω·m) a: Pole plate area (m²)
 l: Distance between pole plates (m) J: Cell constant (m⁻¹)

Resistivity is an index that indicates the difficulty with which current flows and is a constant determined according to the solution. The inverse of "r", which is "L" (and is equal to 1/r), is called the specific conductivity and is widely used as an index to express the ease with which current flows. Specific conductivity "L" is generally referred to as simply conductivity and is expressed in units of S/m.

Inserting conductivity "L" into equation ① results in equation ②, below.

$$R = \frac{J}{L} \dots\dots\dots ②$$

As is clear from equation ② , when a conductivity cell having a cell constant "J" of 1 m^{-1} is used (in other words, when a conductivity cell having two pole plates that each have an area "a" of 1 m^2 and are positioned parallel to each other such that the distance "l" between the two plates is 1 m is used) the inverse of the resistance "R" of the solution between both pole plates is the conductivity. Conductivity is defined in this way, but it changes according to the temperature of the solution. The conductivity of a solution is generally expressed as the value when the solution is 25°C .

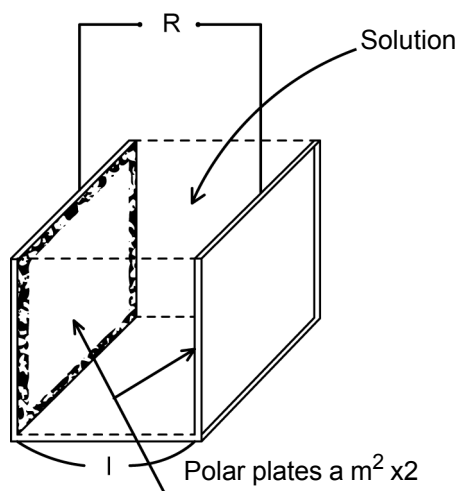

■ For more information

This manual describes conductivity measurement. For detailed information, see "The Story of pH and Water quality" on our website.

This page presents the knowhow we have cultivated over many years, for example, how temperature affects measured values and what to do when you want to measure various samples.

By registering as a user, you can download sample software, refer to technical documents and receive the newsletter each of which contains useful information on water quality measurement.

We look forward to your registration.



■ Options

A wide variety of electrodes and options are available for use with the instrument. You can select the optimum electrode and options for your application and objectives.

These options can be purchased from your nearest agency. Please provide the part name and part number to the representative.

With regard to electrodes, it is important to select the optimum electrode for the sample you want to measure. For details, refer to the catalogue or our website, or contact your dealer.

Part name		Part number	Remarks
AC adapter, Cable (UL, 120 V)		3014031951	
AC adapter, Cable (EU, 230 V)		3014031952	
Plain paper printer	Printer (USA, 120 V)	3014030146	Printer cable sold separately
	Printer (EU, 230 V)	3014030147	
	Printer cable	3014030148	1.5 m
	Roll paper	3014030149	20 rolls/set
	Ink ribbon	3014030150	5 pcs/set
Serial cable		3014030151	
Electrode stand (model DP-70S)		3200528474	
Electrode hook attachment		3200528475	
Electrode cleaning solution for low conductivity water or tap water (model 230)		3200530494	

MEMO

HORIBA, Ltd.

2 Miyanohigashi, Kisshoin Minami-ku, Kyoto 601-8510 Japan
<http://www.horiba.com>

