

Instruction Manual

COND METER DS-71

■ Preface

This manual describes the operation of the DS-71 COND Meter.

Be sure to read this manual before using the product to ensure proper and safe operation of the instrument. Also safely store the manual so it is readily available whenever necessary.

Product specifications and appearance, as well as the contents of this manual are subject to change without notice.

■ Warranty and Responsibility

HORIBA, Ltd. warrants that the Product shall be free from defects in material and workmanship and agrees to repair or replace free of charge, at option of HORIBA, Ltd., any malfunctioned or damaged Product attributable to responsibility of HORIBA, Ltd. for a period of one (1) year from the delivery unless otherwise agreed with a written agreement. In any one of the following cases, none of the warranties set forth herein shall be extended;

- Any malfunction or damage attributable to improper operation
 - Any malfunction attributable to repair or modification by any person not authorized by HORIBA, Ltd.
 - Any malfunction or damage attributable to the use in an environment not specified in this manual
 - Any malfunction or damage attributable to violation of the instructions in this manual or operations in the manner not specified in this manual
 - Any malfunction or damage attributable to any cause or causes beyond the reasonable control of HORIBA, Ltd. such as natural disasters
 - Any deterioration in appearance attributable to corrosion, rust, and so on
- Replacement of consumables

HORIBA, LTD. SHALL NOT BE LIABLE FOR ANY DAMAGES RESULTING FROM ANY MALFUNCTIONS OF THE PRODUCT, ANY ERASURE OF DATA, OR ANY OTHER USES OF THE PRODUCT.

■ Trademarks

Generally, company names and brand names are either registered trademarks or trademarks of the respective companies.

■ Unauthorized Reprinting or Copying of This Operation Manual

No unauthorized reprinting or copying of all or part of this operation manual is allowed. The utmost care has been used in the preparation of this operation manual.

REGULATIONS

■ Conformable Directive

This equipment conforms to the following directives and standards:



Directives: The EMC Directive 2004/108/EC
The Low Voltage Directive 2006/95/EC

Standards: [the EMC Directive] EN61326-1:2006
Class B, Basic requirements
[the Low Voltage Directive] EN61010-1:2010(Ed.3.0)

● Installation Environment

This product is designed for the following environment.

- Overvoltage category II
- Measurement category I

WARNING: Do not use the equipment for measurements within measurement categories II, III and IV.

● Information on Disposal of Electrical and Electronic Equipment and Disposal of Batteries and Accumulators

The crossed out wheeled bin symbol with underbar shown on the product or accompanying documents indicates the product requires appropriate treatment, collection and recycle for waste electrical and electronic equipment (WEEE) under the Directive 2002/96/EC, and/or waste batteries and accumulators under the Directive 2006/66/EC in the European Union.

The symbol might be put with one of the chemical symbols below. In this case, it satisfies the requirements of the Directive 2006/66/EC for the object chemical.

This product should not be disposed of as unsorted household waste. Your correct disposal of WEEE, waste batteries and accumulators will contribute to reducing wasteful consumption of natural resources, and protecting human health and the environment from potential negative effects caused by hazardous substance in products.

Contact your supplier for information on applicable disposal methods.

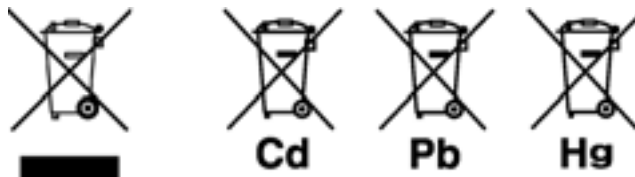

REGULATIONS

■ FCC Rules

Any changes or modifications not expressly approved by the party responsible for compliance shall void the user's authority to operate the equipment.

● WARNING

This equipment has been tested and found to comply with the limits for a Class A digital device, pursuant to part 15 of the FCC Rules. These limits are designed to provide reasonable protection against harmful interference when the equipment is operated in a commercial environment. This equipment generates, uses, and can radiate radio frequency energy and, if not installed and used in accordance with the instruction manual, may cause harmful interference to radio communications.

Operation of this equipment in a residential area is likely to cause harmful interference in which case the user will be required to correct the interference at his own expense.

■ Hazard Classification and Warning Symbols

Warning messages are described in the following manner. Read the messages and follow the instructions carefully.

● Hazard classification



This indicates an imminently hazardous situation which, if not avoided, will result in death or serious injury. This signal word is to be limited to the most extreme situations.



This indicates a potentially hazardous situation which, if not avoided, could result in death or serious injury.



This indicates a potentially hazardous situation which, if not avoided, may result in minor or moderate injury. It may also be used to alert against unsafe practices.

Without safety alert indication of hazardous situation which, if not avoided, could result in property damage.

● Warning symbols



Description of what should be done, or what should be followed









Description of what should never be done, or what is prohibited

SAFETY OPERATION

■ Safety Precautions

This section provides precautions to enable you to use the product safely and correctly and to prevent injury and damage. The terms of DANGER, WARNING, and CAUTION indicate the degree of imminency and hazardous situation. Read the precautions carefully as it contains important safety messages.

 WARNING	
	Do not use an unspecified AC adapter. Otherwise, it may heat up or be ignited resulting in a fire or an accident.
	Do not disassemble or modify the meter. Otherwise, it may heat up or be ignited resulting in a fire or an accident.

 CAUTION	
	Broken glass Broken glass may cause injury. The outer tube and tip of an electrode are made of glass. Handle them with care.
	Do not use the cable of serial communication, USB, or AC adapter under wet or humid conditions. Otherwise, it may cause an fire, electric shock, or breakage.

■ Product Handling Information

● Operational Precautions

- Do not drop, crash, or give any physical impact on the instrument.
- Do not immerse the instrument into alcohol, organic solvent, strong acid, strong alkaline, or the like. The instrument body contains ABS resin, acrylic resin, and some rubber parts.
- If the instrument is dropped into water or gets wet, wipe it using soft cloth. Do not heat to dry it with a hair-dryer (or the like).
- Use fingers to press the operation keys or the touch panel. Do not use a hard object like a metal stick or rod.
- Be careful not to let water into the instruction inside. The instrument is not water-proof.
- To disconnect an electrode or interface cable, hold the connector and pull it off. If you pull at the cable, it may cause a breakage.
- The touch panel is capacitance-type. Make sure to turn OFF the power before cleaning the panel. If you wipe it with the power ON, it may cause instrument malfunction.
- RS-232C or USB communication between the instrument and a personal computer may fail because of environmental conditions, such as (radio/electromagnetic) noise.

● Environmental conditions for use and storage

- Temperature: 0°C to 45°C
- Humidity: under 80% in relative humidity and free from condensation

Avoid the following conditions:

- Dusty environment
- Strong vibration
- Direct sunlight
- Corrosive gas environment
- Close to an air-conditioner
- Direct wind

● Transportation

When transporting the instrument, repackage it in the original package box. Otherwise, it may cause instrument breakage.

● Disposal

Standard solution used for the calibration must be under neutralized before the disposal. As for the disposal of the meter, treat it as an industrial waste.

■ Description in This Manual

— **NOTE** —

This interprets the necessary points for correct operation and notifies the important points for handling the instrument.

— **REF** —

This indicates the part of where to refer the information.

— **HINT!** —

This indicates reference information.

CONTENTS

Chapter 1 About the DS-71	1
Chapter 2 Information of the DS-71	2
2.1 Measurement Items	2
2.2 Packing List	3
2.3 Names and Functions	4
2.3.1 Names of Each Part	4
2.3.2 Display	5
2.3.3 Operation Key	6
2.4 Measurement (MEAS) Flow Chart	7
2.5 Setting (SET) Flow Chart	8
2.6 Data (DATA) Flow Chart	9
Chapter 3 Basic Operation	10
3.1 Preparation	10
3.1.1 Assembling the Electrode Stand	10
3.1.2 Electrode Connection	11
3.1.3 Connecting the Power Source	12
3.1.4 Connecting and Setting the Printer	13
3.1.5 Connecting the Personal Computer	14
3.2 Settings	15
3.2.1 Temperature Compensation Function Setting	15
3.2.2 Auto Data Memory Setting	17
3.2.3 Sample ID Setting	18
3.2.4 Conductivity Unit Setting	19
3.2.5 Conductivity Temperature Coefficient Setting	20
3.2.6 Conductivity Cell Constant Setting	21
3.2.7 Salinity Unit Setting	22
3.2.8 Auto Printer Setting	23
3.2.9 Maintenance	24
3.3 Calibration	39
3.3.1 Conductivity Calibration	39
3.3.2 Salinity Calibration	40

CONTENTS

3.3.3 Calibration Value Printing	42
3.4 Measurement	43
3.4.1 Measurement Value Hold	43
3.4.2 Measurement Items Changing	44
3.4.3 Auto Data Memory	45
3.4.4 Measurement Value Printing	46
3.5 Data Operation	49
3.5.1 Data Memory of Measurement Value	49
3.5.2 Memory Data Display	50
3.5.3 Memory Data Printing	51
Chapter 4 Maintenance and Troubleshooting	53
4.1 Conductivity Electrode Maintenance	53
4.2 Troubleshooting	54
4.2.1 Error Message Chart	54
4.2.2 More Troubleshooting	58
Chapter 5 Specifications	62
5.1 Specifications	62
5.2 Default Settings	64
5.3 Options	65

Chapter 1 About the DS-71

The desktop type COND meter DS-71 is optimized for laboratory measurement, and allows you to measure conductivity, resistivity, salinity, and TDS.

It provides a comfortable measurement environment with the design easy to wipe clean without roughness on the surface, and the free-standing electrode stand and the custom LCD for ease of measurement.

Chapter 2 Information of the DS-71

2.1 Measurement Items

Measurement item	DS-71
Conductivity	√
Salinity	√
Resistivity	√
TDS (Total Dissolved Solids)	√
Temperature	√

2.2 Packing List

The DS-71's package includes the following.

Electrodes are required for the measurement in addition to this package. If you want to buy an electrode, contact HORIBA sales representative.

Product	Quantity
Main unit	1
Electrode stand	1
Instruction Manual	1
Quick Manual	1
AC adapter	1
Ferrite core	1

2.3 Names and Functions

2.3.1 Names of Each Part

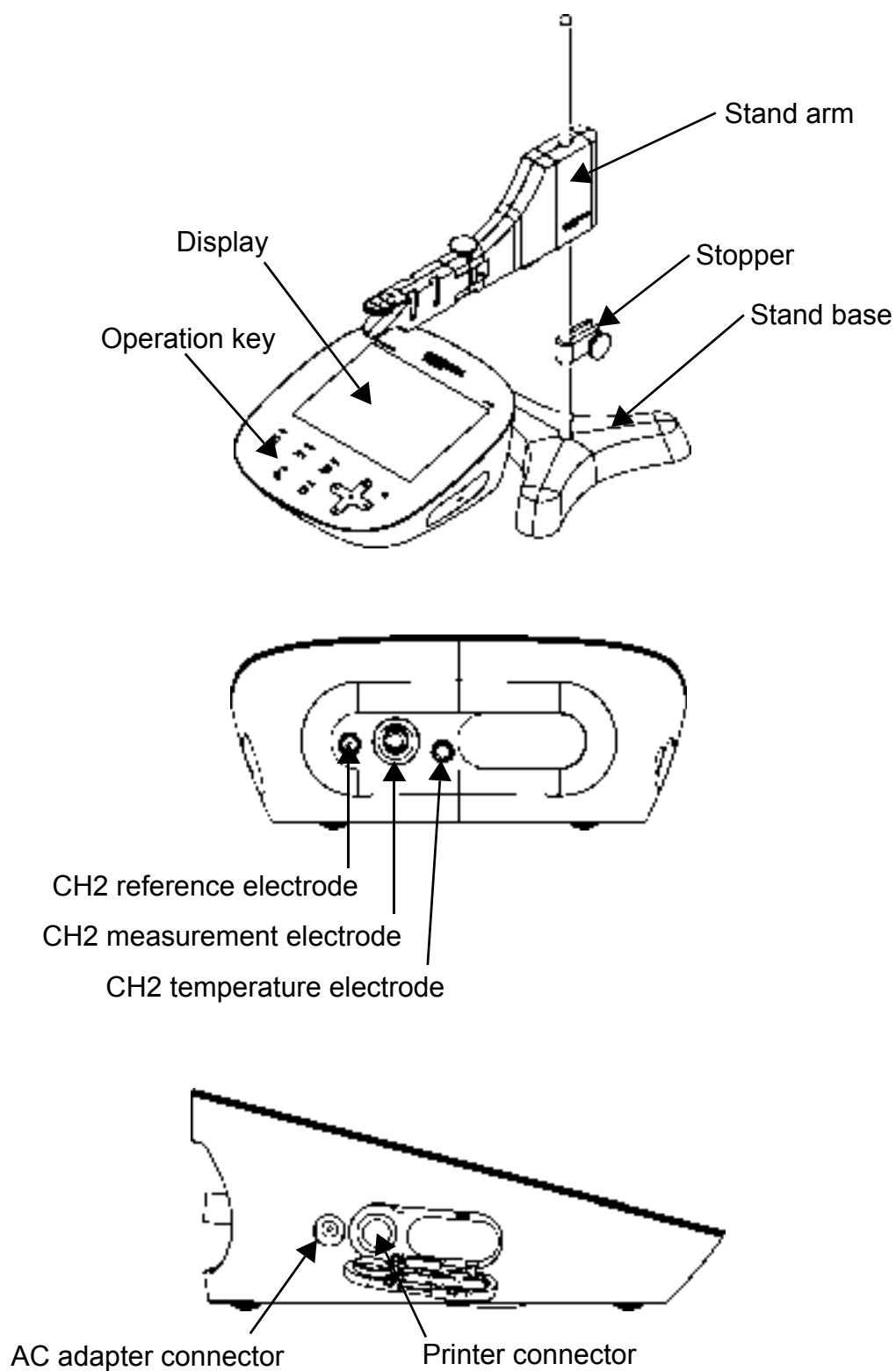

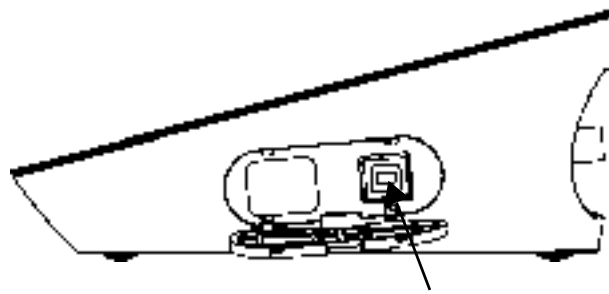





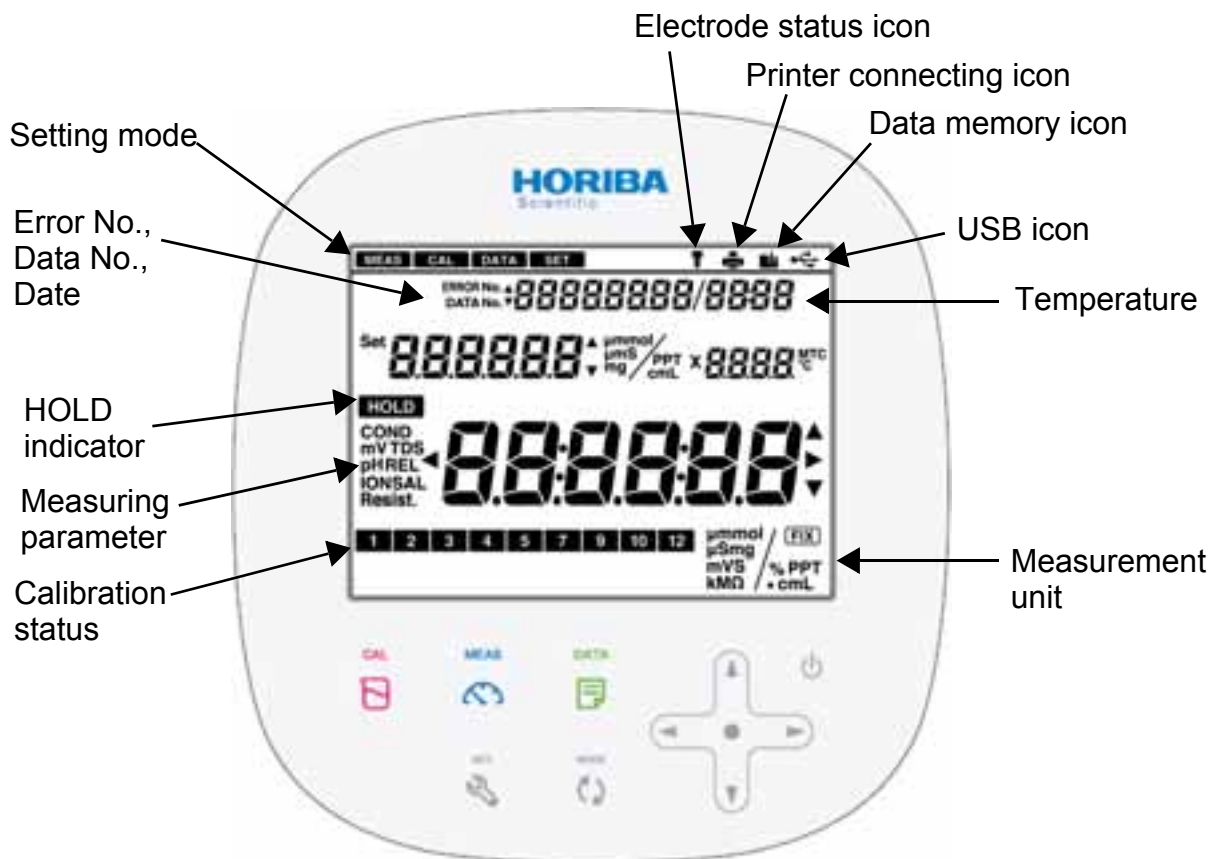



Connector for USB communication with a personal computer

2.3.2 Display

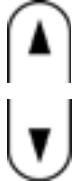

2.3.3 Operation Key

This instrument employs capacitance switches.
You can not operate them with thick gloves. Operate them with bare hands or thin rubber gloves.

Operation key		Function
CAL 	CAL key	Starts/stops calibration or enters the calibration mode.
MEAS 	MEAS key	Starts/stops measurement or enters the measurement mode. Applies the setting values of the setting mode.
DATA 	DATA key	Enters the data operation mode. Printouts calibration value.
SET 	SET key	Enters the setting mode. Cancels the setting values of the setting mode.
MODE 	MODE key	Toggles the measurement items.
	▲ key ▼ key	Increases the values. Decreases the values. Switches the setting item. Switches the CH items.
	◀▶ key	Change number of digits, selects functions. Printouts measurement values. (▶ key)
	ENTER key	Settlement, execution, printout (except measurement values) Start/stops automatic data memory.
	POWER key	Turns ON or OFF the power.

NOTE

Press the POWER key for 1 second or longer to turn ON the power, for 2 seconds or longer to turn OFF the power.

2.4 Measurement (MEAS) Flow Chart

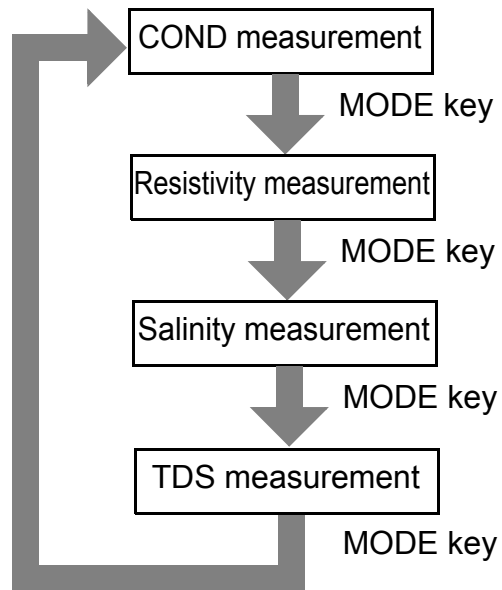

2.5 Setting (SET) Flow Chart

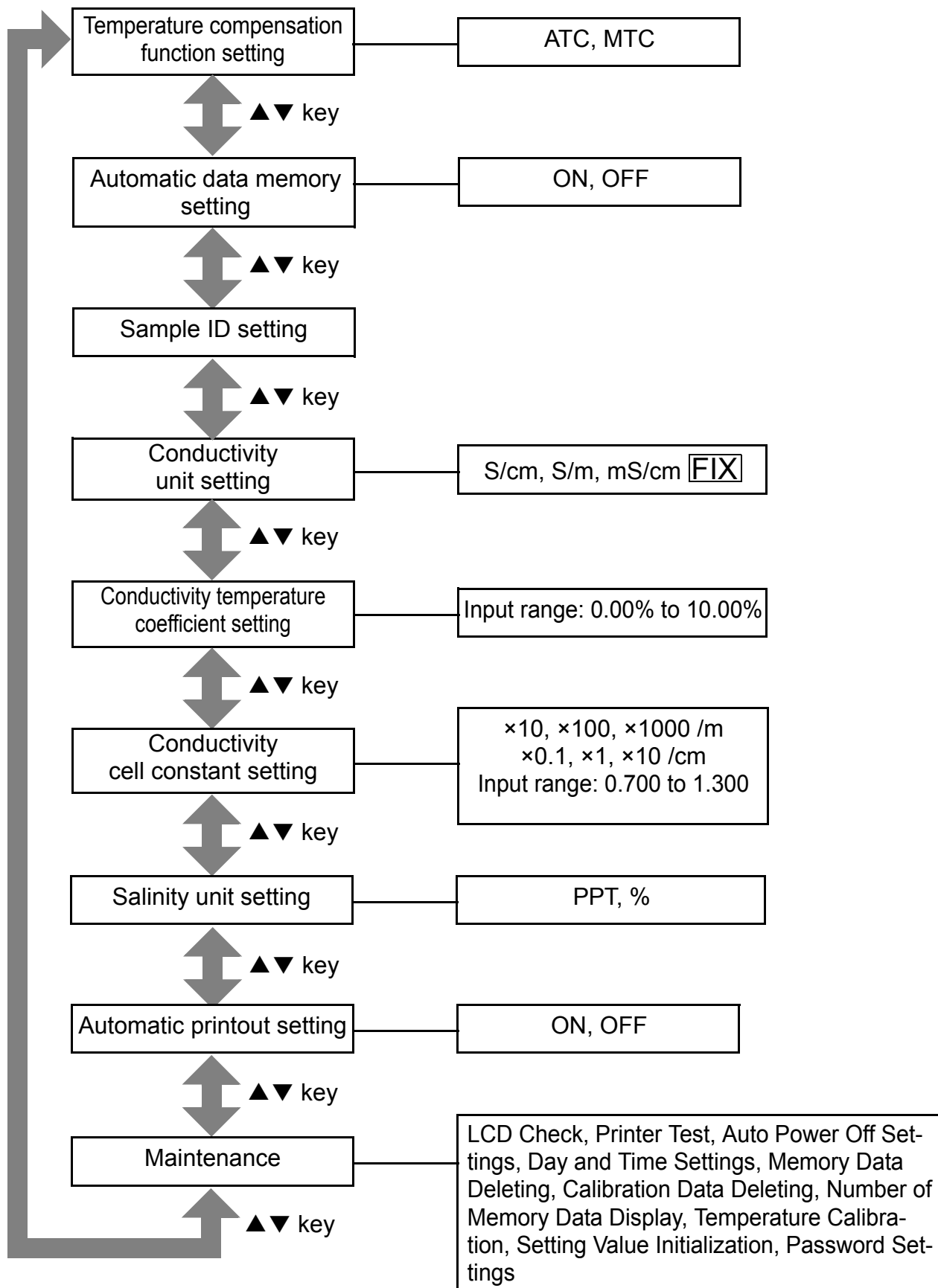

2.6 Data (DATA) Flow Chart

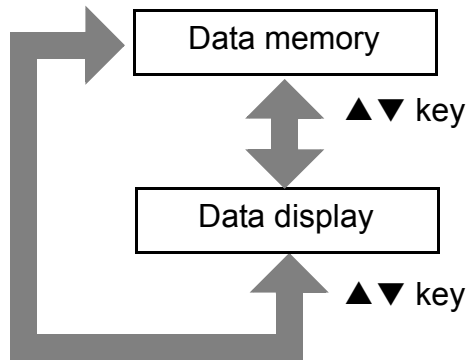

Chapter 3 Basic Operation

3.1 Preparation

3.1.1 Assembling the Electrode Stand

1. Attach the stand shaft to the stand base.
2. Attach the stopper and the stand arm to the stand shaft.

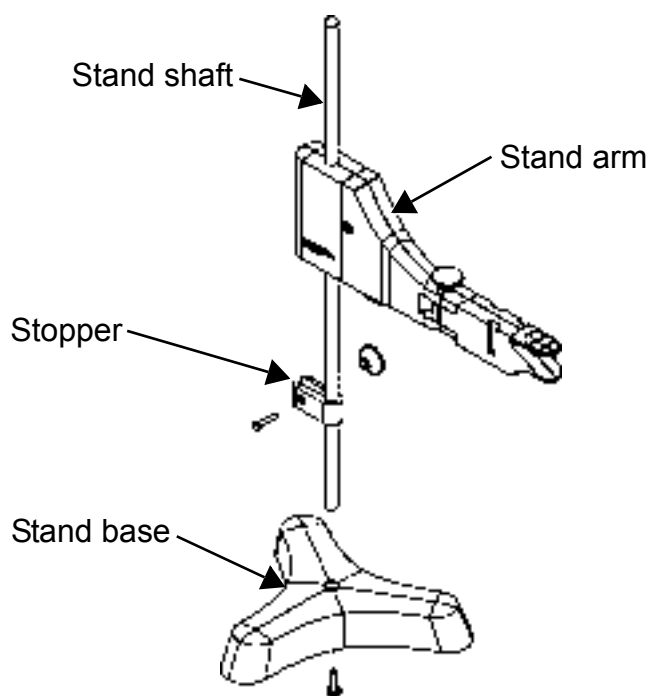

3.1.2 Electrode Connection

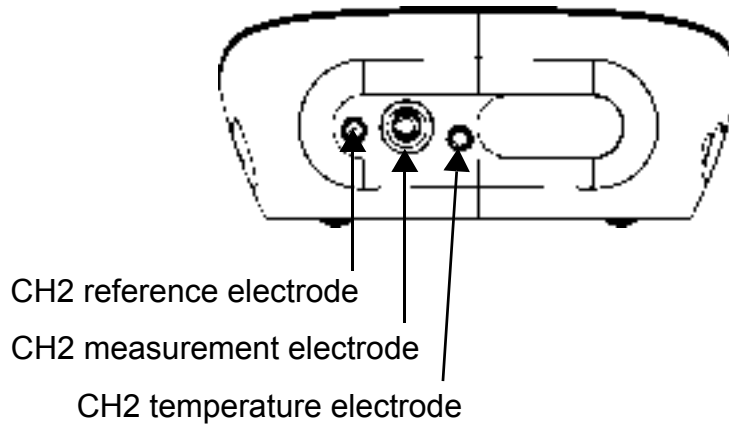

● Electrode connector

1. Insert the groove of electrode plug by fitting it with the socket pin of the instrument.

NOTE

If the pin and groove are misaligned, do not insert the plug with force.

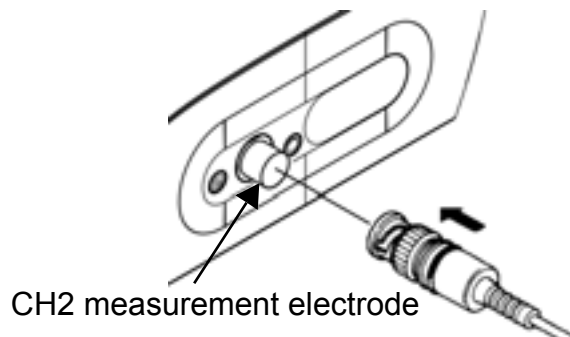

2. Turn the electrode connector to the right along the groove to plug the connector.

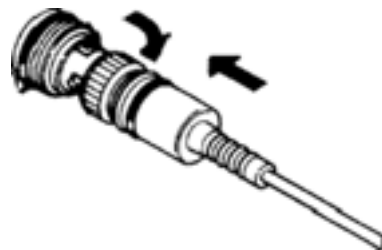

3. Put the connector cover on the connector.

NOTE

Just push the cover on the instrument. Do not screw in it.

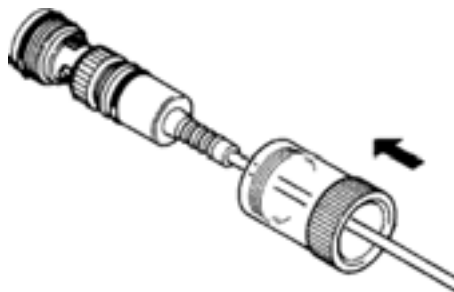

● Temperature connector

1. Insert the temperature connector into the jack socket on the instrument.

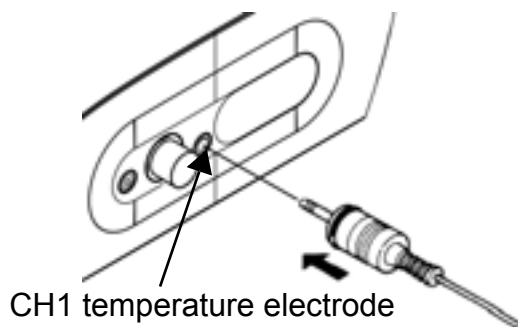

NOTE

If the temperature connector is unconnected or the connection is wrong, the MTC set temperature is displayed as the sample temperature.

3.1.3 Connecting the Power Source

1. Insert the AC adapter cable by fitting with the connector socket of in the instrument.

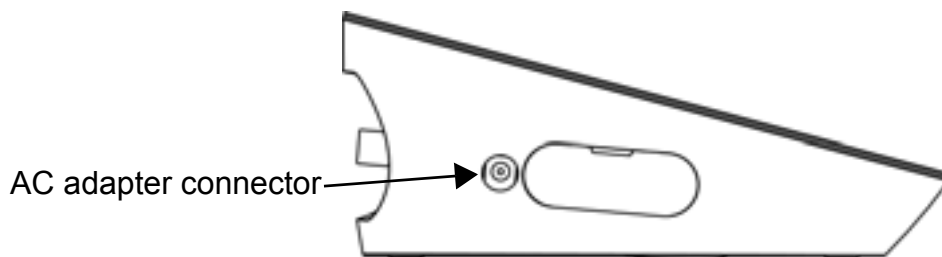

NOTE

- Do not insert the cable with force when the connectors do not match.
 - Attach the provided ferrite core to the AC adapter cable.
-

3.1.4 Connecting and Setting the Printer

● Connecting the Printer

1. Insert the printer cable by fitting with the connector socket of the instrument.

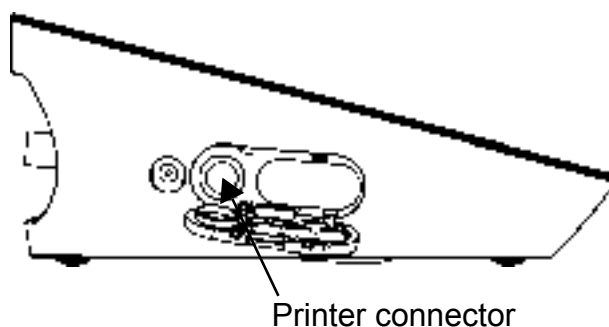

The following printer is possible.

Printer

- CITIZEN CBM-910-24RJ120 V:
plain paper type (Parts No.: 3014030146)
- CITIZEN CBM-910-24RJ230 V:
plain paper type (Parts No.: 3014030147)
- Optional printer cable (Parts No.: 3014030148) is required.

NOTE

- Make sure to use an appropriate cable for the printer.
 - Make sure to power OFF the instrument before connecting a printer.
 - When you do not connect a printer with the instrument, disconnect the printer cable and put the rubber cap firmly on the connector sockets on the instrument.
-

● Setting the Printer

Refer to the instruction manual of the printer for settings and operations of the printer.

- (1) Set the DIP switch No. 6 to ON and No. 7 to OFF, and then set printer paper and ink ribbon. Keep the LF key held down.
- (2) Keep the SEL key held down.
The printer prints output when the SEL key is being pressed.

3.1.5 Connecting the Personal Computer

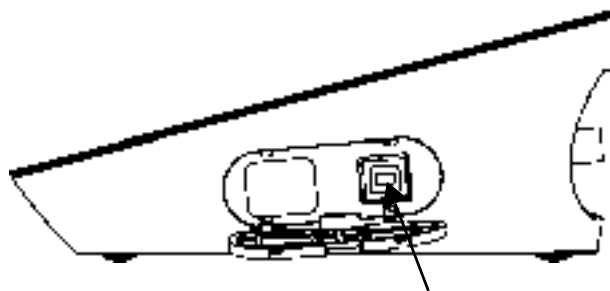

Personal computer communication connector

- Use proprietary cables to connect with a personal computer.
Proprietary cable
Parts name: USB cable (1 m)
Parts No.: 3200373941
- Make sure that the transfer formats of the measuring instrument and personal computer are same.
Otherwise, communication may fail due to a communication error or the online mode start failure.
If you change the transfer formats, power OFF both of the instrument and the personal computer once, and then turn on them again.
- For the details of communication commands, register with our website and see the free download page of manuals.

3.2 Settings

This section describes the procedures of the instrument condition settings for measurement, calibration, and maintenance.

The settings apply when you press the MEAS key to return to the measurement screen.

If you press the SET key during setting or after pressing the ENTER key, the settings are cancelled.

3.2.1 Temperature Compensation Function Setting

You can perform temperature compensation for conductivity electrode outputs.

1. Press the SET key on the measurement screen to enter the temperature compensation function setting screen.



2. Press the ENTER key to enter the temperature compensation function change screen.
3. Press the ◀ or ▶ key to change ATC or MTC, and press the ENTER key.

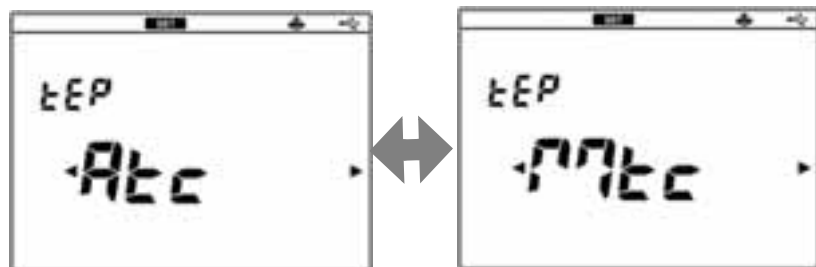

4. If you select MTC, press the ◀ or ▶ key to select a digit and press the ▲ or ▼ key to change the value, and then press the ENTER key.

Setting range: 0°C to 100°C



ATC

In Automatic Temperature Compensation (ATC), the instrument detects the solution temperature. When the temperature sensor is connected, the current temperature of the solutions is displayed automatically. If the sensor is not connected, the set value for MTC (default: 25°C) is displayed.

MTC

In Manual Temperature Compensation (MTC), the temperature sensor of the electrode is not used, and the solution temperature is entered manually.

3.2.2 Auto Data Memory Setting

Data memory can be performed automatically at a regular interval.

1. Press the SET key on the measurement screen, and press the ▲ or ▼ key to enter the auto data memory setting screen.



2. Press the ENTER key to enter the auto data memory change screen.
3. Press the ◀ or ▶ key to change ON or OFF, and press the ENTER key.

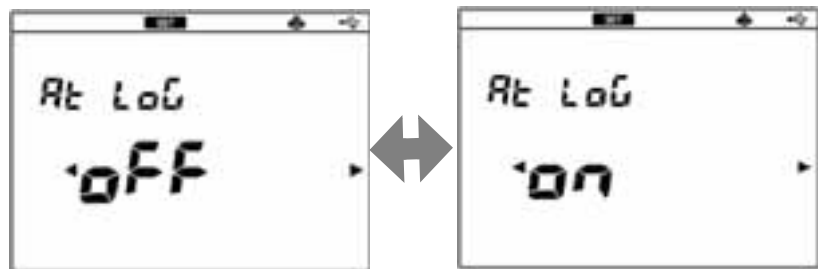

4. If you select ON, press the ◀ or ▶ key to select a digit and press the ▲ or ▼ key to change the value, and then press the ENTER key.

Setting range: 2 seconds to 24 hours



3.2.3 Sample ID Setting

If a sample ID is set here, it is recorded together with the measurement data at the data memory and it allows you to search data easily.

1. Press the SET key on the measurement screen, and press the ▲ or ▼ key to enter the sample ID setting screen.



2. Press the ENTER key to enter the sample ID change screen.
3. Press the ◀ or ▶ key to select digit and press the ▲ or ▼ key to change value, and press the ENTER key.

Setting range: 0 to 9999



3.2.4 Conductivity Unit Setting

Select the unit of electric conductivity measurement among S/cm, S/m, and mS/cm **FIX**. When mS/cm **FIX** is selected, the unit is fixed to mS/cm.

1. Press the SET key on the measurement screen, and press the ▲ or ▼ key to enter the conductivity unit setting screen.



2. Press the ENTER key to enter the conductivity unit change screen.
3. Press the ◀ or ▶ key to select S/cm, S/m or mS/cm **FIX**, and press the ENTER key.

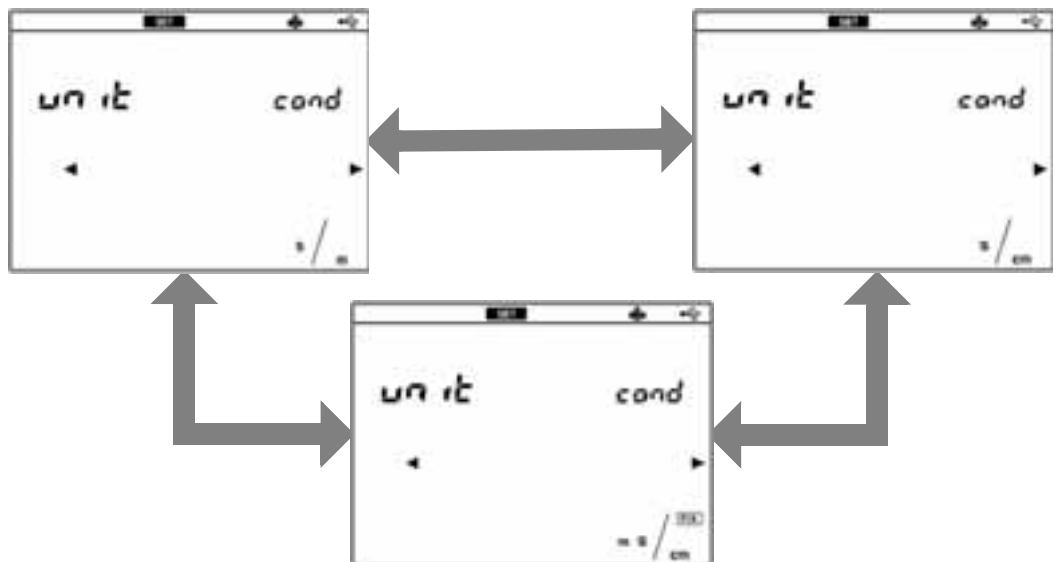

3.2.5 Conductivity Temperature Coefficient Setting

Set the coefficient used for temperature compensation in electric conductivity measurement (Input range: 0.00% to 10.00%). The default is 2.00%.

1. Press the SET key on the measurement screen, and press the ▲ or ▼ key to enter the conductivity unit setting screen.



2. Press the ENTER key to enter the conductivity temperature coefficient change screen.
3. Press the ◀ or ▶ key to change ON or OFF, and press the ENTER key.

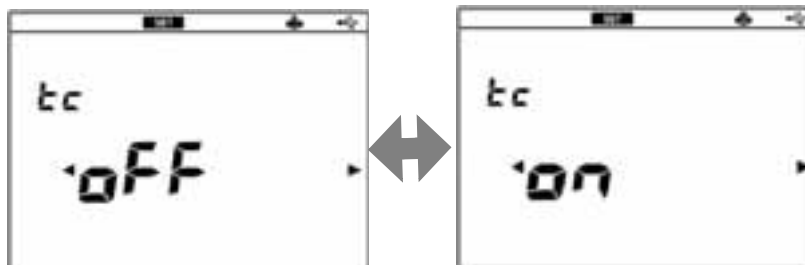

4. Press the ◀ or ▶ key to select digit and press the ▲ or ▼ key to change value, and ENTER key.
Setting range: 0.00% to 10.00%



3.2.6 Conductivity Cell Constant Setting

Set the cell constant of electrode (Setting range: 0.700 to 1.300). When using an electrode for the instrument for the first time, set the cell constant written on the label of the electrode.

1. Press the SET key on the measurement screen, and press the ▲ or ▼ key to enter the conductivity cell constant setting screen.



2. Press the ENTER key to enter the conductivity cell constant change screen.

When the ◀ or ▶ key is pressed, the display changes depending on the current unit setting.

For the SI unit (S/m)

×10 → ×100 → ×1000 → ×10

For the conventional units (S/cm, mS/cm FIX)

×0.1 → ×1 → ×10



3. Press the ENTER key.

4. Press the ◀ or ▶ key to select digit and press the ▲ or ▼ key to change value, and press the ENTER key.

Setting range: 0.700 to 1.300



3.2.7 Salinity Unit Setting

You can select the unit of salinity measurement between PPT and %.

1. Press the SET key on the measurement screen, and press the ▲ or ▼ key to enter the salinity unit setting screen.

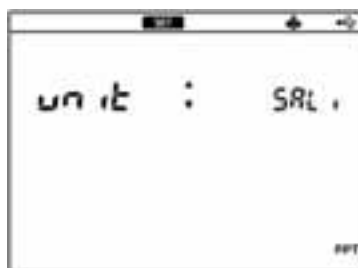

2. Press the ENTER key to enter the salinity unit change screen.
3. Press the ◀ or ▶ key to select PPT or %, and press the ENTER key.

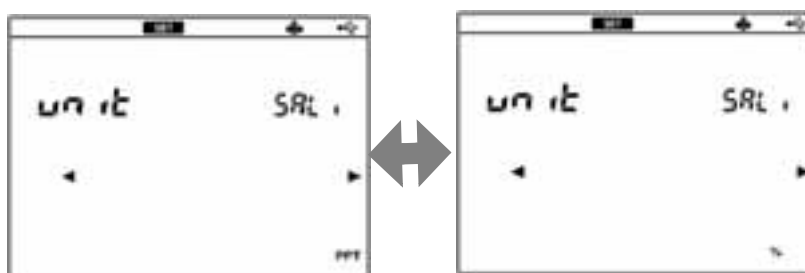

3.2.8 Auto Printer Setting

You can set automatic printout when a printer is connected.

When this setting is ON, automatic printout is executed at the following occasions.

- You perform data memory during measurement.
- Calibration or check is completed in the calibration mode.

1. Press the SET key on the measurement screen, and press the ▲ or ▼ key to enter the auto printer setting screen.



2. Press the ENTER key to enter the auto printer setting change screen.
3. Press the ◀ or ▶ key to select ON or OFF, and press the ENTER key.

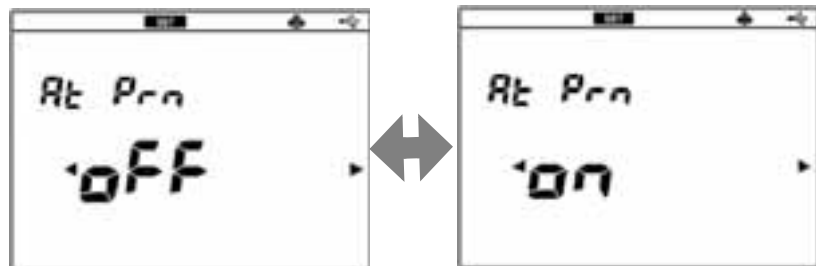

4. Press the ENTER key to return to the maintenance item selecting screen.



● Printer Test

You can check the printer connection and printout operation.

1. Press the SET key on the measurement screen, and press the ▲ or ▼ key to enter the maintenance screen.



2. Press the ENTER key to enter the maintenance item selecting screen.



3. Press the ▲ or ▼ key to enter the printer test screen.

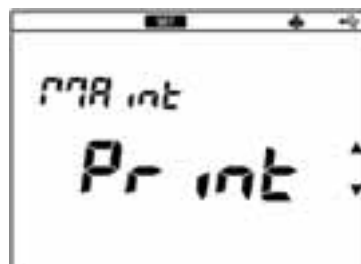

4. Press the ENTER key to start the printing.

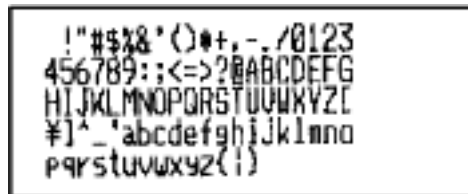
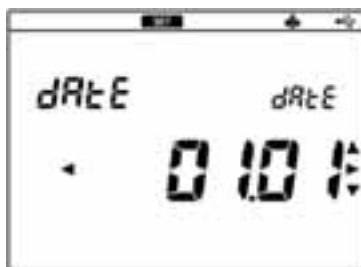

5. Press the ENTER key to return to the printer test screen.

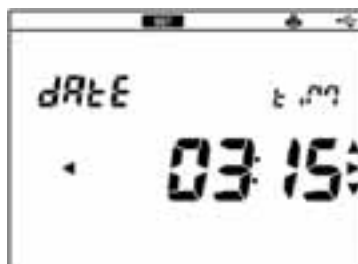

● Auto Power Off Setting

You can set ON/OFF of the auto power off function. When this function is ON and no key operations are performed for the set period, the instrument is powered OFF automatically.

1. Press the SET key on the measurement screen, and press the ▲ or ▼ key to enter the maintenance screen.

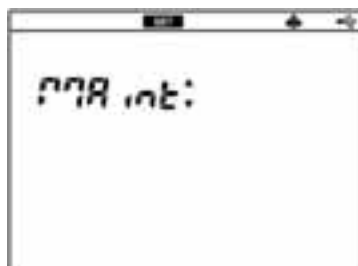

2. Press the ENTER key to enter the maintenance item selecting screen.



3. Press the ▲ or ▼ key to enter the auto power off setting screen.

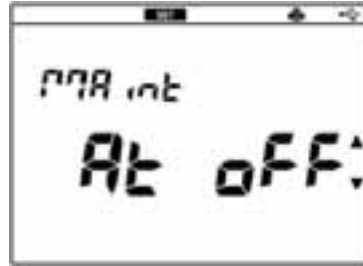

4. Press the ENTER key to enter the auto power off change screen.
5. Press the ◀ or ▶ key to change ON or OFF, and press the ENTER key.

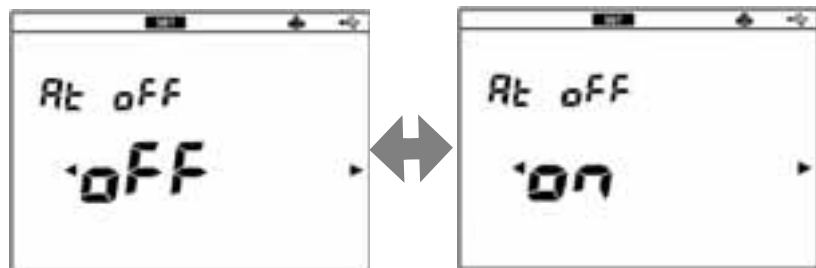

6. Press the ◀ or ▶ key to select a digit and press the ▲ or ▼ key to change the value, and then press the ENTER key and press the ENTER key to return to the auto power off change screen.

Setting range: 1 to 30 minutes

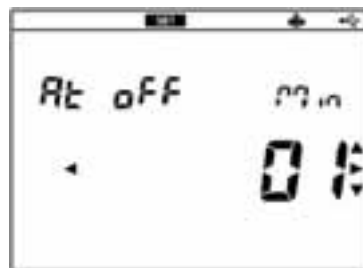

● Date Setting

Perform this operation when you use the instrument for the first time or replace the lithium batteries.

1. Press the SET key on the measurement screen, and press the ▲ or ▼ key to enter the maintenance screen.

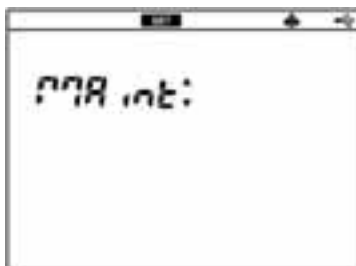

2. Press the ENTER key to enter the maintenance item selecting screen.



3. Press the ▲ or ▼ key to enter the date setting screen.



4. Press the ENTER key to enter the year setting screen. Press the ◀ or ▶ key to select a digit and press the ▲ or ▼ key to change the value, and then press the ENTER key.



5. Press the ◀ or ▶ key to select a digit and press the ▲ or ▼ key to change the value for month and day setting, and then press the ENTER key.



6. Press the ◀ or ▶ key to select a digit and press the ▲ or ▼ key to change the value for hour and minute setting, and press the ENTER key to return to the date setting screen.



● Memory Data Clearing

You can delete the memory data of the instrument. This operation is irreversible. We recommend printing out or saving data into a PC ("3.1.5 Connecting the Personal Computer" P.14) before this operation.

1. Press the SET key on the measurement screen, and press the ▲ or ▼ key to enter the maintenance screen.



2. Press the ENTER key to enter the maintenance item selecting screen.



3. Press the ▲ or ▼ key to enter the memory data clear screen.



4. Press the ENTER key to enter the memory data clear (Yes/No) screen.



5. Press the ◀ or ▶ key to select Yes, and press ENTER key to delete the memory data.
When the deletion is completed, "End" is displayed.

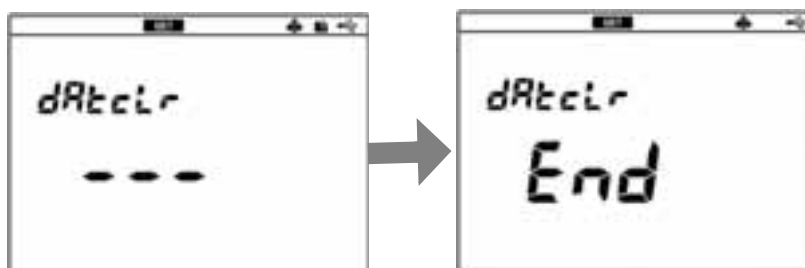

6. Press the ENTER key to return to the memory data clear screen.

● Calibration Data Clearing

You can delete the calibration data of conductivity and salinity to initialize them.

Note that this operation is irreversible.

1. Press the SET key on the measurement screen, and press the ▲ or ▼ key to enter the maintenance screen.



2. Press the ENTER key to enter the maintenance item selecting screen.



3. Press the ▲ or ▼ key to enter the calibration data clear screen.



4. Press the ENTER key and the ◀ or ▶ key to select the measurement item to be deleted.

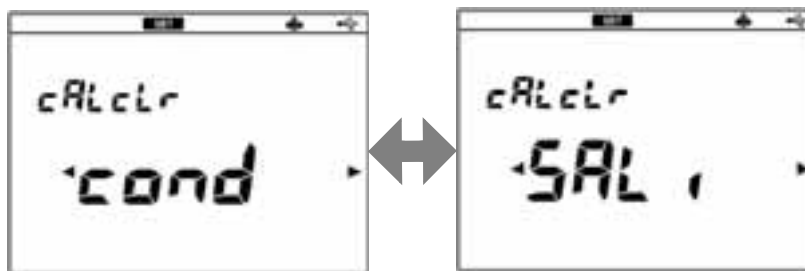

5. Press the ENTER key to enter the calibration data deleting (Yes/No) screen.

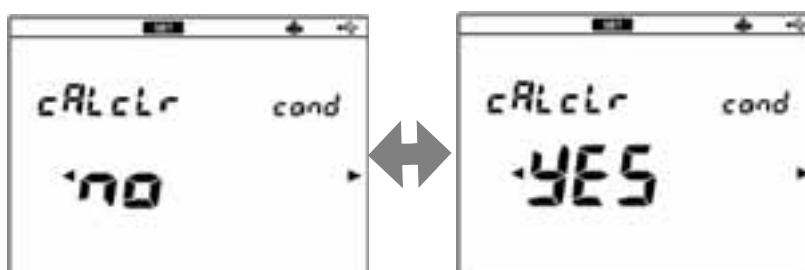

6. Press the ◀ or ▶ key to select Yes, and press ENTER key to delete the calibration data.
When the deletion is completed, "End" is displayed.



7. Press the ENTER key to return to the calibration data clear screen.

● Number of Memory Data Display

The number of memory data saved in the instrument is displayed. You can store up to 999 data.

1. Press the SET key on the measurement screen, and press the ▲ or ▼ key to enter the maintenance screen.



2. Press the ENTER key to enter the maintenance item selecting screen.



3. Press the ▲ or ▼ key to enter the number of memory data display screen.



4. Press the ENTER key to display the number of the memory data currently saved in the instrument.



5. Press the ENTER key to return to the number of memory data display screen.

● Temperature Calibration

You can perform calibration of the temperature sensor of an electrode.

1. Press the SET key on the measurement screen, and press the ▲ or ▼ key to enter the maintenance screen.

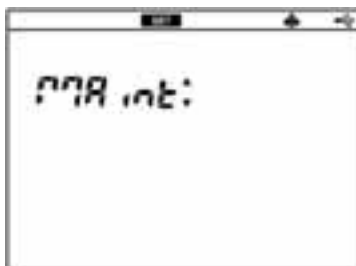

2. Press the ENTER key to enter the maintenance item selecting screen.



3. Press the ▲ or ▼ key to enter the temperature calibration screen.



4. Press the ENTER key to enter the temperature display value change screen.

5. Press the ◀ or ▶ key to select a digit and press the ▲ or ▼ key to change the value, and then press the ENTER key to return to the temperature calibration screen.



● Setting Initialization

The settings are initialized.

Refer to "5.2 Default Settings" P.64 for default settings.

1. Press the SET key on the measurement screen, and press the ▲ or ▼ key to enter the maintenance screen.



2. Press the ENTER key to enter the maintenance item selecting screen.



3. Press the ▲ or ▼ key to enter the initializing settings screen.



4. Press the ENTER key to enter the initializing settings (Yes/No) screen.

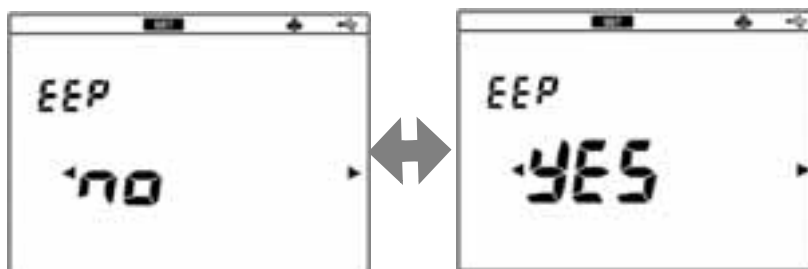

5. Press the ◀ or ▶ key to select Yes, and press ENTER key to initialize the settings.
The initializing is complete when "End" is displayed.

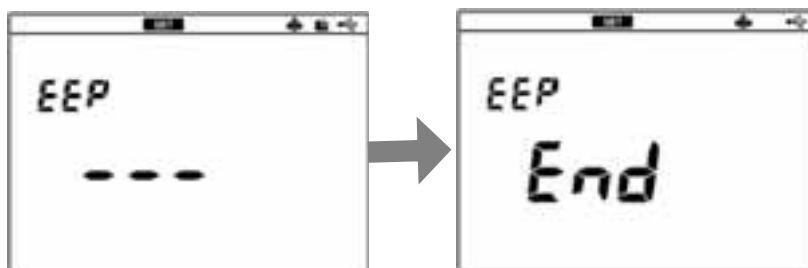

6. Press the ENTER key to return to the initializing settings screen.

● Password Setting

This function prevents an unauthorized person from tampering the date of measurement data, or operating accidentally to change settings, delete memory data, etc.

1. Press the SET key on the measurement screen, and press the ▲ or ▼ key to enter the maintenance screen.



2. Press the ENTER key to enter the maintenance item selecting screen.



3. Press the ▲ or ▼ key to enter the password settings screen.



4. Press the ENTER key to enter the password change screen.

5. Press the ◀ or ▶ key to change ON or OFF, and press the ENTER key.

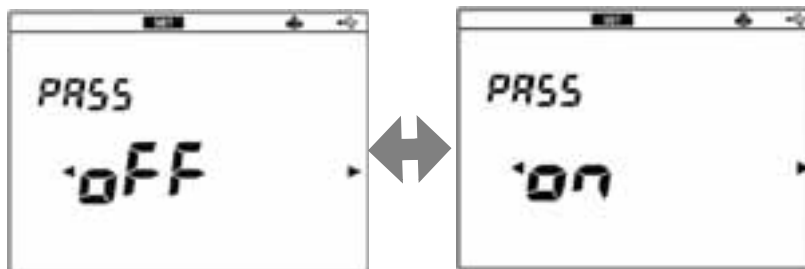

6. If you select ON, press the ◀ or ▶ key to select a digit and press the ▲ or ▼ key to change the value, and then press the ENTER key and press the ENTER key to return to the password change screen.

Setting range: 0000 to 9999

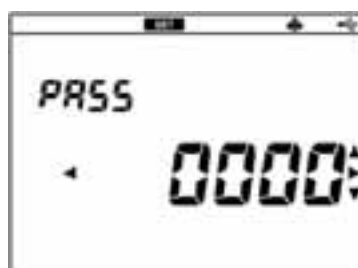

NOTE

If this setting is ON, password entry is required when you power ON the instrument. Enter the password and press the ENTER key.

If you forget the password, contact HORIBA sales representative.

3.3 Calibration

3.3.1 Conductivity Calibration

The cell constant of the electrode may change according to the using conditions. The recommended calibration of the cell constant is approximately once a year. The calibration updates the cell constant to be appropriate for the current electrode.

1. Prepare the potassium chloride standard solution. Refer to "JIS K 0400" for the preparative method.
2. Wash the electrode with pure water (deionized), and wipe it off by filter paper or tissue paper.
3. Immerse the electrode in the potassium chloride standard solution of the second point.
4. Press the CAL key on the measurement screen is displayed to enter the calibration screen.
5. Press the ◀ or ▶ key to select digit and press the ▲ or ▼ key to change value, to set the value of the desired standard solution.



6. Check the stable indication value, and press the CAL key.

The HOLD indicator blinks until the reading stabilizes. When the reading stabilizes, the HOLD indicator lights up and the reading is held.

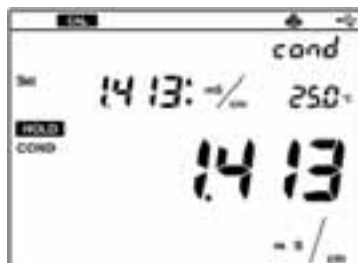

7. After the calibration is completed, press the MEAS key to return to the measurement screen.

3.3.2 Salinity Calibration

You can perform 1 point calibration using a salinity standard solution.

1. Prepare the electrode.
Wash the electrode with pure water (deionized), and wipe it off by filter paper or tissue paper.
2. Immerse the electrode in the desired standard solution used for calibration.
3. Press the MODE key on the measurement screen to enter the salt measurement screen.
4. Press the CAL key to enter the salinity calibration screen.
5. Press the ◀ or ▶ key to select digit and press the ▲ or ▼ key to change value, to set the value of the desired standard solution.

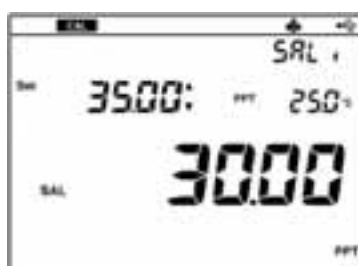

6. Check the stable indication value, and press the CAL key.

The HOLD indicator blinks until the reading stabilizes. When the reading stabilizes, the HOLD indicator lights up and the reading is held.



7. After the calibration is completed, press the MEAS key to return to the measurement screen.

3.3.3 Calibration Value Printing

You can print out the data during calibration HOLD or calibration error.

1. Check the printer settings and that the printer is connected correctly. (Refer to "3.1.4 Connecting and Setting the Printer" P.13.)
2. Press the DATA key during calibration HOLD or calibration error. The currently displayed data is printed out.

Printing examples are shown below.

● Printing at COND calibration

Inst. model :DS-71	①	① Instrument model ② Serial number ③ Cell constant ④ Calibration data
Inst. SN :123456789	②	
CELL : 0.973x1000 m-1	③	
Calibration data Date :2011/03/10 Time :18:44 98.64 S/m : 25.0°C MTC Temp. Coef : 2.00%/°C	④	

● Printing at salinity calibration

Inst. model :DS-71	①	① Instrument model ② Serial number ③ Calibration coefficient ④ Calibration data
Inst. SN :123456789	②	
Cal. Coef :1.00	③	
Calibration data Date :2011/03/21 Time :20:42 11.13PPT : 25.0°C ATC Temp. Coef : 2.00%/°C	④	

3.4 Measurement

3.4.1 Measurement Value Hold

The instrument can hold the measurement value automatically when it judges that the value is stable. Press the MEAS key when the instantaneous value is displayed in the instantaneous measurement, and the HOLD indicator blinks. Then, when the value is stable, the HOLD indicator lights up and the value is held. To cancel the HOLD state or to stop the stability judgment (HOLD blinking), press the MEAS key again.

● Stabilization Criteria

Conductivity, resistivity, salinity, and TDS measurements:

Display change in 10 seconds: within ± 3 digit

Temperature measurement:

Temperature change in 10 seconds: within $\pm 2^{\circ}\text{C}$



3.4.2 Measurement Items Changing

When the MODE key is pressed, measurement item can be changed.

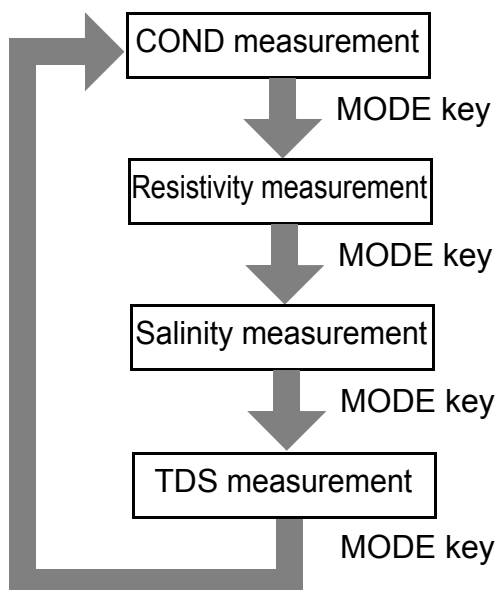

3.4.3 Auto Data Memory

The instrument can perform data memory automatically at a regular interval. Refer to "3.2.2 Auto Data Memory Setting" P.17 for the setting operations.

If the auto power off setting is ON, it is temporarily OFF while this function is active.

1. After the interval setting is completed, press the MEAS key to return to the measurement screen. "Auto LOG" is displayed on the screen.



2. Press the ENTER key. "Auto LOGGING" is displayed on the screen, and the auto data memory function starts.



3. To stop the auto data memory, press the ENTER key.

NOTE

- Do not power ON/OFF while the auto data memory function works. It may damage the reliability of the memory data.
- Only the POWER, ENTER, and the ▲ or ▼ keys are possible while the auto data memory function works.
- The actual date of memory may have the difference of ± 1 second from the time calculated based on the interval setting.
- When the number of memory data exceeds 999, data memory is stopped and ERROR No.0010 is displayed.

3.4.4 Measurement Value Printing

You can print out measurement values or the HOLD value.

When the automatic printout setting is ON, automatic printout is executed at the following occasions.

- You perform data memory during measurement.
- Calibration or check is completed in the calibration mode.

1. Check that the printer settings and connection are correctly. (Refer to "3.1.4 Connecting and Setting the Printer" P.13.)
2. Press the ► key in the measurement mode or HOLD state. The currently displayed measurement value is printed out. Printing examples are shown below.

● Conductivity measurement mode

Date	:2011/03/21	
Time	:19:31	
COND	: 1.90 S/m	
HOLD	:INST	①
Temperature	:	
	25.0°C ATC	②
Sample	:0000	③
Inst. model	:DS-71	④
Inst. SN	:123456789	⑤
CELL	:	
	1.014x100 m-1	⑥
Temp. Coef	: 2.00%/°C	⑦

- ① HOLD condition
At HOLD: AUTO
Instant value: INST
- ② Temperature compensation setting
At Manual mode: MTC
At Auto mode: ATC
- ③ Sample ID
- ④ Instrument model
- ⑤ Serial number
- ⑥ Cell constant
- ⑦ Temperature coefficient

● Salinity measurement mode

Date	:2011/03/10	
Time	:19:22	
SAL	:0.048%	
HOLD	:INST	①
Temperature	:	
	25.0°C MTC	②
Sample	:0007	③
Inst. model	:DS-71	④
Inst. SN	:123456789	⑤
Cal. Coef	:1.00	⑥
Temp. Coef	:2.00%/°C	⑦

- ① HOLD condition
At HOLD: AUTO
Instant value: INST
- ② Temperature compensation setting
At Manual mode: MTC
At Auto mode: ATC
- ③ Sample ID
- ④ Instrument model
- ⑤ Serial number
- ⑥ Calibration coefficient
- ⑦ Temperature coefficient

● TDS measurement mode

Date	:2011/03/10	
Time	:19:22	
TDS	: 519mg/L	
HOLD	:INST	①
Temperature	:	
	25.0°C MTC	②
Sample	:0007	③
Inst. model	:DS-71	④
Inst. SN	:123456789	⑤
Temp. Coef	:2.00%/°C	⑥

- ① HOLD condition
At HOLD: AUTO
Instant value: INST
- ② Temperature compensation setting
At Manual mode: MTC
At Auto mode: ATC
- ③ Sample ID
- ④ Instrument model
- ⑤ Serial number
- ⑥ Temperature coefficient

● Resistivity measurement mode

Date	:2011/03/10
Time	:19:23
Resist	:
	10.27 ohm·m
HOLD	:INST
Temperature	:
	25.0°C MTC
Sample	:0007
Inst. model	:DS-71
Inst. SN	:123456789
Temp. Coef	: 2.00%/°C

- ① HOLD condition
At HOLD: AUTO
Instant value: INST
- ② Temperature compensation setting
At Manual mode: MTC
At Auto mode: ATC
- ③ Sample ID
- ④ Instrument model
- ⑤ Serial number
- ⑥ Temperature coefficient

3.5 Data Operation

3.5.1 Data Memory of Measurement Value

Measurement data can be stored into the instrument memory.

Refer to "3.4.3 Auto Data Memory" P.45 for automatic data memory.

1. Press the DATA key to enter the data operation screen.



2. Press the ENTER key to enter the data memory screen.

The measurement value and "IN" are alternately displayed.

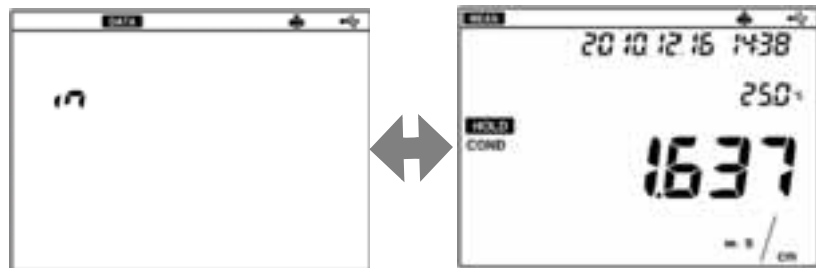

3. Press the ENTER key.
The measurement data is stored into the memory.

3.5.2 Memory Data Display

The memory data can be displayed on the screen.

1. Press the DATA key to enter the data operation mode.



2. Press the ▲ or ▼ key to enter the memory data display screen.

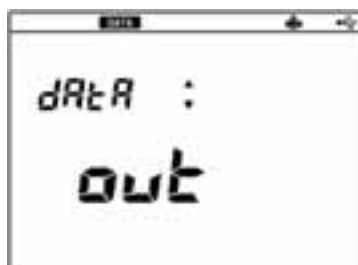

3. The latest data is displayed.



4. Press the ◀ or ▶ key to switch between date display and DATA No/ID No. display. Press the ▲ or ▼ key to search past data.

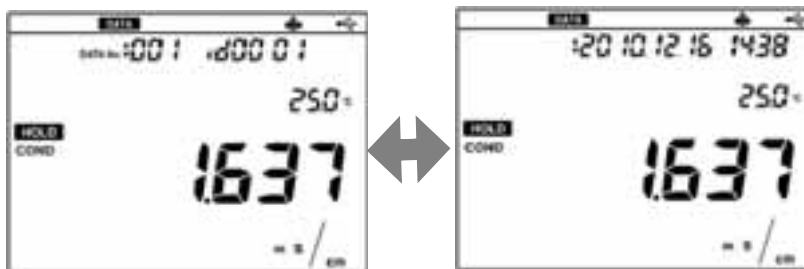

3.5.3 Memory Data Printing

The memory data can be printed out.

1. Display the memory data referring to "3.5.2 Memory Data Display" P.50.
2. Press the ENTER key.

The displayed measurement data is printed out.

● COND measurement mode

Memory Num :004	①
Date :2011/03/21	
Time :19:56	
COND : 1.92 S/m	
HOLD :INST	②
Temperature :	
25.0°C ATC	③
Sample :0000	④
Inst. model :DS-71	⑤
Inst. SN :123456789	⑥

- ① Memory number
- ② HOLD condition
At HOLD: AUTO
Instant value: INST
- ③ Temperature compensation setting
At Manual mode: MTC
At Auto mode: ATC
- ④ Sample ID
- ⑤ Instrument model
- ⑥ Serial number

● Resistivity measurement mode

Memory Num :005	①
Date :2001/01/01	
Time :12:35	
Resist :	
0.51 ohm·m	
HOLD :AUTO	②
Temperature :	
25.0°C ATC	③
Sample :0000	④
Inst. model :DS-71	⑤
Inst. SN :123456789	⑥

- ① Memory number
- ② HOLD condition
At HOLD: AUTO
Instant value: INST
- ③ Temperature compensation setting
At Manual mode: MTC
At Auto mode: ATC
- ④ Sample ID
- ⑤ Instrument model
- ⑥ Serial number

● Salinity measurement mode

Memory Num :006	①
Date :2001/01/01	
Time :12:36	
SAL :11.30PPT	
HOLD :AUTO	②
Temperature :	
25.0°C ATC	③
Sample :0000	④
Inst. model :DS-71	⑤
Inst. SN :123456789	⑥

- ① Memory number
- ② HOLD condition
At HOLD: AUTO
Instant value: INST
- ③ Temperature compensation setting
At Manual mode: MTC
At Auto mode: ATC
- ④ Sample ID
- ⑤ Instrument model
- ⑥ Serial number

● TDS measurement mode

Memory Num :007	①
Date :2001/01/01	
Time :12:36	
TDS :10.8 g/L	
HOLD :AUTO	②
Temperature :	
25.0°C ATC	③
Sample :0000	④
Inst. model :DS-71	⑤
Inst. SN :123456789	⑥

- ① Memory number
- ② HOLD condition
At HOLD: AUTO
Instant value: INST
- ③ Temperature compensation setting
At Manual mode: MTC
At Auto mode: ATC
- ④ Sample ID
- ⑤ Instrument model
- ⑥ Serial number

Chapter 4 Maintenance and Troubleshooting

This chapter explains the daily maintenance operations and error messages.

Daily maintenance is vital in assuring accurate measurement and preventing breakage from occurring. If electrode maintenance is neglected, it may cause various problems and erroneous measurements. This instrument is equipped with a convenient error message function. If an error message appears, be sure to take appropriate countermeasures.

4.1 Conductivity Electrode Maintenance

Refer to the electrode operation manuals for the maintenance operations of each electrode.

Long-term storage

When an electrode will not be used for a long period of time, store it after performing the following procedures. Also, perform the maintenance of the electrode every 3 to 6 months.

1. Disconnect the electrode from the instrument.
2. Use pure water to wash away any sample solution that may be adhered to the electrode.
3. Wash the inside of the electrode protective cap with pure water, then, after shaking out the water, fill the cap with enough pure water to soak the sponge.
4. Place the electrode protective cap on the electrode.

4.2 Troubleshooting

This instrument is equipped with a simple error-message function to notify the operator that an operation error or problem with the equipment has occurred. Errors or other problems that occur in the measurement mode are announced by an "ERROR No." appearing in the upper lefthand corner of the screen.

4.2.1 Error Message Chart

ERROR No.	Message	Definition
0001	Memory ERROR	Data cannot be read from or written to the internal memory.
0003	Unstable reading ERROR	The electric potential does not stabilize within three minutes.
0009	Printer communication ERROR	There is a problem with the printer communication.
0010	Data memory over	The number of the memory data exceeds the limit of the memory.
0011	Cell constant out of range	COND: The cell constant is out of the automatic calculation range.
000E	Key operation ERROR	Key operation is invalid.

● ERROR No.0001 Memory ERROR

Definition

Data cannot be read from or written to the internal memory.

Cause	Countermeasure
The instrument does not start properly due to noise or other at power ON.	Disconnect and reconnect the AC adapter, and press the ON/OFF key 10 seconds later. If the same error occurs again after the countermeasure is performed, contact HORIBA sales representative.
The internal IC is defective.	Contact HORIBA sales representative.

● ERROR No.0003 Unstable reading ERROR

Definition

The electric potential does not stabilize within three minutes.

Cause	Countermeasure
This is caused by the effect of the sample solution The sample solution is pure water or other solution with low conductivity, or the pH concentration or temperature change.	Press the MEAS key again while "HOLD" blinks or lights up, to measure the sample using instantaneous value measurement.
The electrode is dirty.	Wash the electrode.
The electrode is cracked.	Replace the electrode.
The responsive glass membrane of the electrode has been dry for a long time.	Soak the membrane (on the electrode) in pure water (deionized) for 24 hours.

Cause	Countermeasure
The temperature of the sample solution is fluctuating.	Measure after the sample solution temperature stabilizes.

● ERROR No.0009 Printer communication ERROR

Definition

There is a problem with the printer communication.

Power OFF the instrument and perform the countermeasures below, and then power ON again.

Cause	Countermeasure
There is a problem with the printer unit connection.	Check the printer connection, and connect the instrument and printer again.
The printer is defective.	Replace the printer. If the same error occurs again after the countermeasure is performed, contact HORIBA sales representative.

● ERROR No.0010 Data memory over

Definition

The number of the memory data exceeds the limit of the memory.

Cause	Countermeasure
Memory over	Check the contents of the memory data, and delete unnecessary data.

● ERROR No.0011 Cell constant out of range

Definition

The cell constant is out of the automatic calculation range.

Cause	Countermeasure
COND electrode is at the end of the useful life.	Replace the electrode.
Improper standard solution	Prepare new standard solution.

● ERROR No.000E Key operation ERROR

Definition

Key operation is invalid.

Cause	Countermeasure
Loose connection or breaking of keys	Disconnect and reconnect the AC adapter, and press the ON/OFF key 10 seconds later. If the same error occurs again after the countermeasure is performed, contact HORIBA sales representative.

4.2.2 More Troubleshooting

This section describes the countermeasures for the troubles that are not indicated by ERROR messages.

● The indicated value fluctuates

When there is a problem with the electrode.

Cause	Countermeasure
There are air bubbles on the electrode.	Shake the electrode to remove the air bubbles.
Plating has separated.	Replace the electrode.

When there is a problem with the instrument

Cause	Countermeasure
There is a motor or other device causing electrical interference.	Measure at a place where no influence from induction is given. Ground all AC-powered equipment
The electrode is not connected correctly.	Connect the electrode correctly.

● **The indicated value does not change/No response.**

Cause	Countermeasure
Key operation is invalid.	Disconnect and reconnect the AC adapter, and press the ON/OFF key 10 seconds later. If the same error occurs again, seek repairs at contact HORIBA sales representative.
The electrode connector is not attached correctly.	Turn the power OFF, then turn it back ON again.
The electrode is defective.	Replace the electrode.
The pH meter is defective.	Contact HORIBA sales representative.

● **The details when the AC adapter is disconnected.**

Cause	Countermeasure
No lithium battery is set.	Set the lithium battery (CR2032).
The lithium battery runs down.	Replace the lithium battery (CR2032).

NOTE

Refer to " ● Date Setting" P.28, and set date and time.

Lithium battery replacement

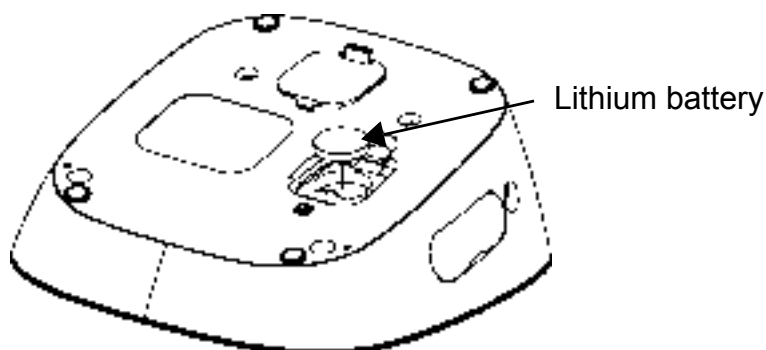

● **The measured value is blinks.**

- The conductivity value is outside the display range (when conductivity value is displayed).

Display range:

0.00 to 19.99 (when cell constant is 100 m⁻¹)

Cause	Countermeasure
The sample is inappropriate.	Use a sample within the measurement range.
The instrument is defective.	Perform the check operation mentioned below.
The meter has not been calibrated or it has been calibrated incorrectly.	Calibrate the meter correctly.

Check operation

Conductivity, salinity, TDS

Disconnect the electrode.

If the displayed measurement value is near 0, the instrument is normal.



● **The temperature display blinks.**

The temperature display is fixed at 25°C.

The temperature measurement value is outside the measurement range.

Measurement range: -30°C to 130°C

Cause	Countermeasure
The temperature of the sample is outside display range.	Check the sample temperature. Adjust it within the measurement range.
The internal thermistor connection of the electrode is broken or shorted.	Check the resistance of the temperature sensor connector. If it is 50 kΩ or more at room temperature, replace the electrode.
The connection of the temperature connector is failed.	Insert the temperature connector firmly.
The instrument is defective.	Contact HORIBA sales representative.

Cause	Countermeasure
The settings of the temperature calibration is failed.	Initialize the settings referring to " ● Setting Initialization" P.35.

● **Printout is not made even when a printer is connected.**

Check the following points.

- Is the printer turned ON?
- Is an error occurred in printer?
- Is the printing paper run out or clogged?
- When the test print is made according to the manual, is it done correctly?

Chapter 5 specifications

5.1 Specifications

● Measuring object

Measuring object	Item	Description	DS-71
Temperature	Measuring principle	Thermistor method	√
	Measuring range	0.0°C to 100.0°C	√
	Display resolution	0.1°C	√
	Repeatability	±0.1°C ±1 digit	√
Conductivity	Measuring principle	2 AC bipolar method	√
	Measuring range	Cell constant 100 m ⁻¹ 0.000 mS/m to 19.99 S/m Cell constant 10 m ⁻¹ 0.0 μS/m to 1.999 S/m Cell constant 1000 m ⁻¹ 0.00 mS/m to 199.9 S/m	√
	Display resolution	0.05% of full scale	√
	Repeatability	±0.5% ±1 digit of full scale	√

Measuring object	Item	Description	DS-71
Resistivity	Measuring principle	Conversion from conductivity value	√
	Measuring range	Cell constant 100 m ⁻¹ : 0.00 Ω•m to 199.9 kΩ•m Cell constant 10 m ⁻¹ : 0.0 Ω•m to 1.999 MΩ•m Cell constant 1000 m ⁻¹ : 0.000 Ω•m to 19.99 kΩ•m	√
	Display resolution	0.05% of full scale	√
	Repeatability	±0.5% ±1 digit of full scale	√
Salinity	Measuring principle	Conversion from conductivity value	√
	Measuring range	0.00 PPT to 80.00 PPT (0.000% to 8.000%)	√
	Display resolution	0.01PPT (0.001%)	√
TDS	Measuring principle	Conversion from conductivity value	√
	Measuring range	0.01 mg/L to 100 g/L	√
	Display resolution	0.01 mg/L	√

● Functions

Item	DS-71
PC USB interface	√
Memory number	999
Calibration points	5
Password setting	√
Printer connection	√

5.2 Default Settings

Item	Description	Default value
Common settings	Temperature compensation	Automatic temperature compensation (ATC)
	Manual temperature compensation value	25°C
	Auto power off	OFF
	Sample ID	0000
	Calibration interval	OFF
	Password	OFF
	Auto data memory	OFF
	Auto print	OFF
Conductivity	Unit	S/m
	Temperature coefficient	2.00%/°C (ON)
	Cell constant	1.000 × 100 m ⁻¹
Salinity	Unit	PPT

5.3 Options

This section lists spare and optional parts for the instrument. These parts are possible through HORIBA distributors. Place an order specifying their names, and part numbers.

Part name		Part number	Remarks
AC adapter	AC adapter, Cable (UL, 120 V)	3014031951	
	AC adapter, Cable (EU, 230 V)	3014031952	
Plain paper printer	Printer (USA 120 V)	3014030146	Printer cable sold separately
	Printer (EU, 230 V)	3014030147	
	Printer cable	3014030148	1.5 m
	Roll paper	3014030149	20 rolls/set
	Ink ribbon	3014030150	5 pcs/set
Serial cable		3014030151	1 m
USB cable		3200373941	
Electrode stand (Standard type)		3200382557	
Electrode stand (Long type)		3200382560	
Stand arm		3200373991	
Sensor holder		3200373961	
X-51 Digital Simulator		—	For pH, mV, ION, DO
X-52 Digital Simulator		—	For COND

For any question regarding this product,
please contact your local agency,
or inquire from the Customer Registration website
(<http://www.horiba.com/register>)

HORIBA Ltd.

1st edition: October 2011
CODE: GZ0000260899

